

Introduction to LabVIEW

Hans-Petter Halvorsen

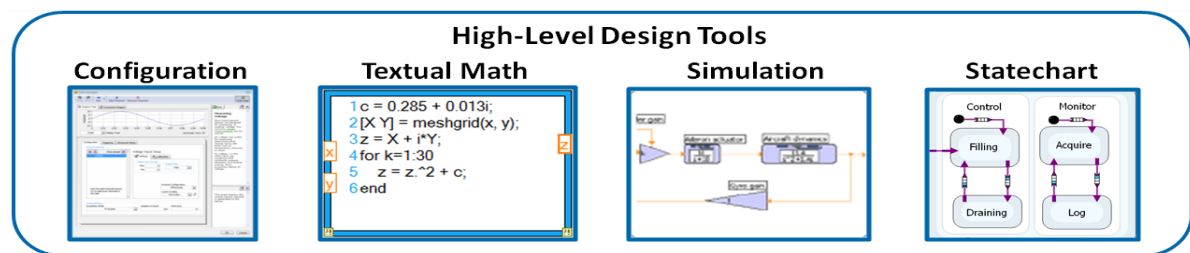

LabVIEW

Graphical Programming

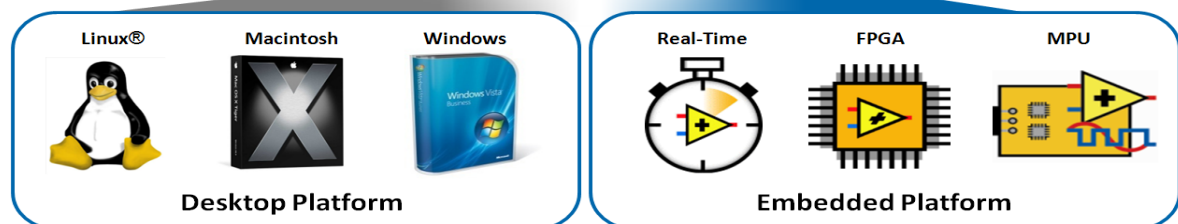

Introduction to LabVIEW

Hans-Petter Halvorsen

Copyright © 2017

E-Mail: hans.p.halvorsen@usn.no

Web: <https://www.halvorsen.blog>



<https://www.halvorsen.blog>

Preface

This document explains the basic concepts of LabVIEW.

You find additional resources, code, etc. here:

<https://www.halvorsen.blog/documents/programming/labview/>

Table of Contents

Preface	iii
Table of Contents	iv
1 Introduction	1
1.1 Dataflow Programming.....	1
1.2 Graphical Programming.....	1
1.3 Benefits.....	2
2 Start using LabVIEW	4
2.1 The LabVIEW Environment.....	4
2.2 Front Panel	5
2.3 Block Diagram.....	7
2.4 Controls Palette	10
2.4.1 Numeric Sub Palette.....	12
2.4.2 Boolean Sub Palette	12
2.4.3 String & Path Sub Palette	13
2.5 Function Palette.....	13
2.6 Tools Palette	14
2.7 Wiring	16
2.8 Toolbar.....	16
2.9 Execution	17
2.10 The Objects short-cut menu	18
2.11 Dataflow Programming.....	19
2.12 Help.....	20
Exercises.....	20

3	Sub VIs.....	24
3.1	Create New Sub VI from Scratch.....	25
3.1.1	Input and Output SubVI Connectors	26
3.1.2	Icon Editor	28
3.2	Create Sub VI from existing code.....	29
3.3	Using Sub VIs	30
	Exercises.....	31
4	Customize LabVIEW.....	33
	Exercises.....	34
5	Loops and Structures.....	35
5.1	Loops.....	35
5.1.1	For Loop.....	36
5.1.2	While Loop	37
5.2	Structures	38
5.2.1	Case Structure	38
5.2.2	Sequence Structure	39
5.2.3	Event Structure.....	40
	Exercises.....	42
6	Troubleshooting and Debugging	45
6.1	How to find errors	45
6.2	Highlight Execution	45
6.3	Probes.....	46
6.4	Breakpoints.....	47
6.5	Step into/over/out debugging.....	48
	Exercises.....	48

7	Working with Data	50
7.1	Arrays.....	50
7.1.1	Auto-Indexing	50
7.1.2	Array Functions	51
7.2	Cluster.....	53
7.2.1	Cluster Order	54
7.2.2	Cluster Elements.....	55
	Exercises.....	56
8	Working with Strings	58
	Exercises.....	60
9	Error Handling	62
9.1	Finding Error	62
9.2	Error Wiring	62
9.3	Error Handling in SubVIs	63
9.4	Error Handling.....	64
	Exercises.....	65
10	Working with Projects	66
10.1	Project Explorer.....	66
10.2	Deployment.....	67
	Exercises.....	69
11	Design Techniques.....	71
11.1	Force Program Flow	71
11.2	Shift Register	72
11.3	State Programming Architecture	73
11.4	Multiple Loops/Parallel programming	75

11.5	Templates.....	77
	Exercises.....	78
12	User Interface.....	80
12.1	VI Properties	81
	Exercises.....	84
13	Plotting Data.....	85
13.1	Customizing.....	87
	Exercises.....	89
14	Tips & Tricks	91
14.1	10 functions you need to know about	91
14.2	The 10 most useful Short-cuts	96
15	Example Application.....	97
16	Additional Exercises	101
17	What's Next?.....	106
17.1	My Blog	106
17.2	Tutorials	106
17.3	Additional Resources	106
17.4	Examples	107
	Quick Reference	108

1 Introduction

LabVIEW (short for **L**aboratory **V**irtual **I**nstrumentation **E**ngineering **W**orkbench) is a platform and development environment for a visual programming language from National Instruments. The graphical language is named "G". Originally released for the Apple Macintosh in 1986, LabVIEW is commonly used for data acquisition, instrument control, and industrial automation on a variety of platforms including Microsoft Windows, various flavors of UNIX, Linux, and Mac OS X. The latest version of LabVIEW is version LabVIEW 2011. Visit National Instruments at www.ni.com.

The code files have the extension ".vi", which is an abbreviation for "Virtual Instrument". LabVIEW offers lots of additional Add-Ons and Toolkits.

1.1 Dataflow Programming

The programming language used in LabVIEW, also referred to as G, is a dataflow programming language. Execution is determined by the structure of a graphical block diagram (the LV-source code) on which the programmer connects different function-nodes by drawing wires. These wires propagate variables and any node can execute as soon as all its input data become available. Since this might be the case for multiple nodes simultaneously, G is inherently capable of parallel execution. Multi-processing and multi-threading hardware is automatically exploited by the built-in scheduler, which multiplexes multiple OS threads over the nodes ready for execution.

1.2 Graphical Programming

LabVIEW ties the creation of user interfaces (called front panels) into the development cycle. LabVIEW programs/subroutines are called virtual instruments (VIs). Each VI has three components: a block diagram, a front panel, and a connector panel. The last is used to represent the VI in the block diagrams of other, calling VIs. Controls and indicators on the front panel allow an operator to input data into or extract data from a running virtual instrument. However, the front panel can also serve as a programmatic interface. Thus a virtual instrument can either be run as a program, with the front panel serving as a user interface, or, when dropped as a node onto the block diagram, the front panel defines the inputs and outputs for the given node through the connector pane. This implies each VI can be easily tested before being embedded as a subroutine into a larger program.

The graphical approach also allows non-programmers to build programs simply by dragging and dropping virtual representations of lab equipment with which they are already familiar. The LabVIEW programming environment, with the included examples and the documentation, makes it simple to create small applications. This is a benefit on one side, but there is also a certain danger of underestimating the expertise needed for good quality "G" programming. For complex algorithms or large-scale code, it is important that the programmer possess an extensive knowledge of the special LabVIEW syntax and the topology of its memory management. The most advanced LabVIEW development systems offer the possibility of building stand-alone applications. Furthermore, it is possible to create distributed applications, which communicate by a client/server scheme, and are therefore easier to implement due to the inherently parallel nature of G-code.

1.3 Benefits

One benefit of LabVIEW over other development environments is the extensive support for accessing instrumentation hardware. Drivers and abstraction layers for many different types of instruments and buses are included or are available for inclusion. These present themselves as graphical nodes. The abstraction layers offer standard software interfaces to communicate with hardware devices. The provided driver interfaces save program development time. The sales pitch of National Instruments is, therefore, that even people with limited coding experience can write programs and deploy test solutions in a reduced time frame when compared to more conventional or competing systems. A new hardware driver topology (DAQmxBase), which consists mainly of G-coded components with only a few register calls through NI Measurement Hardware DDK (Driver Development Kit) functions, provides platform independent hardware access to numerous data acquisition and instrumentation devices. The DAQmxBase driver is available for LabVIEW on Windows, Mac OS X and Linux platforms.

This document introducing the following themes:

- Start using LabVIEW
 - The LabVIEW Environment
 - Front Panel and Block Diagram
 - Palettes: Control Palette, Functions Palette, Tools Palette
 - Data Types
 - Property Nodes
- Sub VIs
- Loops and Structures
- Troubleshooting and Debugging
- Working with Data

- Arrays
 - Array Functions
- Cluster
- Working with Strings
- Error Handling
- Working with Projects using Project Explorer
- Design Techniques
 - Shift Register
 - State Machine
 - Multiple Loops
- User Interface
- Plotting Data
- Deployment: Building Executable Applications (.exe)
- Introduction to Add-Ons and Toolkits
 - Briefly explanations...
 - More detail about Control and Simulation Module in later
- Introduction to DAQ - Data Acquisition
 - MAX – Measurement and Automation Explorer
 - NI-DAQmx
- Quick Reference with Keyboard Short-cuts

For more information about LabVIEW, visit my Blog:

<https://www.halvorsen.blog>

2 Start using LabVIEW

This chapter explains the basic concepts in LabVIEW.

The topics are as follows:

- The LabVIEW Environment
- Front Panel and Block Diagram
- Palettes: Control Palette, Functions Palette, Tools Palette
- Data Types
- Property Nodes

2.1 The LabVIEW Environment

LabVIEW programs are called **V**irtual **I**nstruments, or **VIs**, because their appearance and operation imitate physical instruments, such as oscilloscopes and multimeters. LabVIEW contains a comprehensive set of tools for acquiring analyzing, displaying, and storing data, as well as tools to help you troubleshoot your code.

When opening LabVIEW, you first come to the “Getting Started” window.

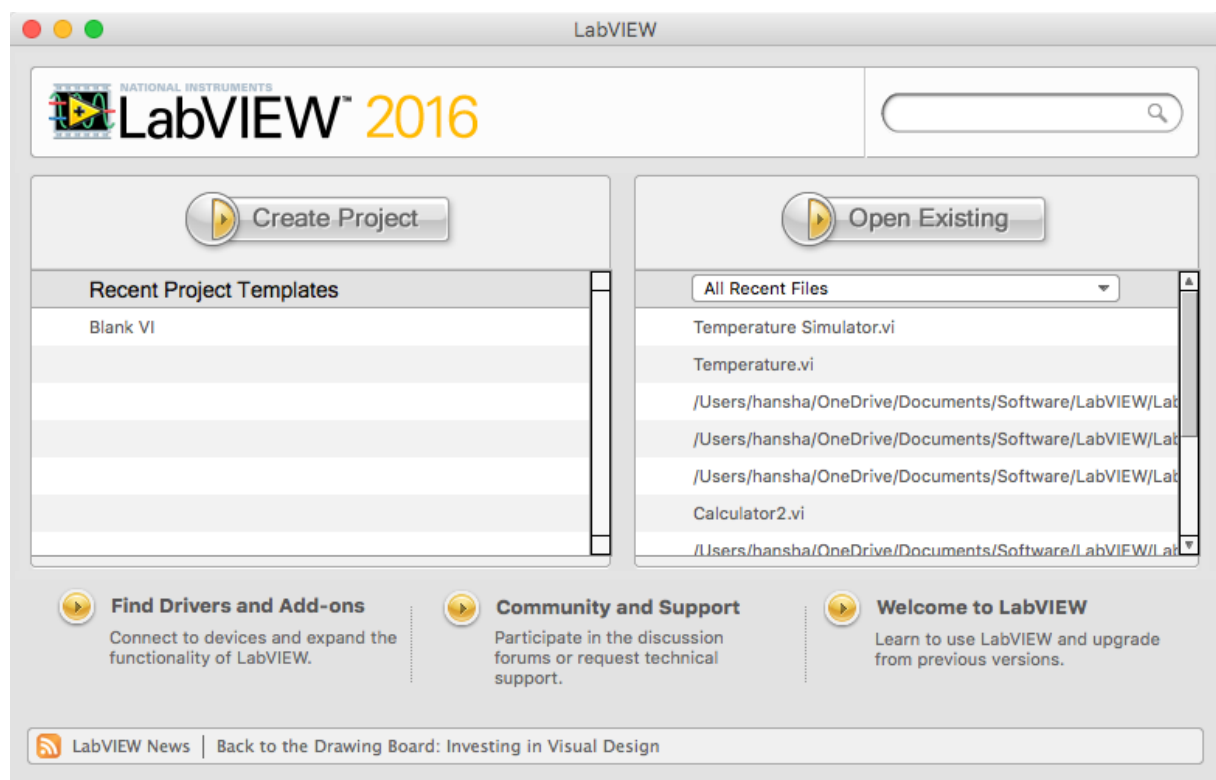

In order to create a new VI, select “Blank VI” or in order to create a new LabVIEW project, select “Empty project”.

When you open a blank VI, an untitled front panel window appears. This window displays the front panel and is one of the two LabVIEW windows you use to build a VI. The other window contains the block diagram. The sections below describe the front panel and the block diagram.

2.2 Front Panel

When you have created a new VI or selected an existing VI, the Front Panel and the Block Diagram for that specific VI will appear.

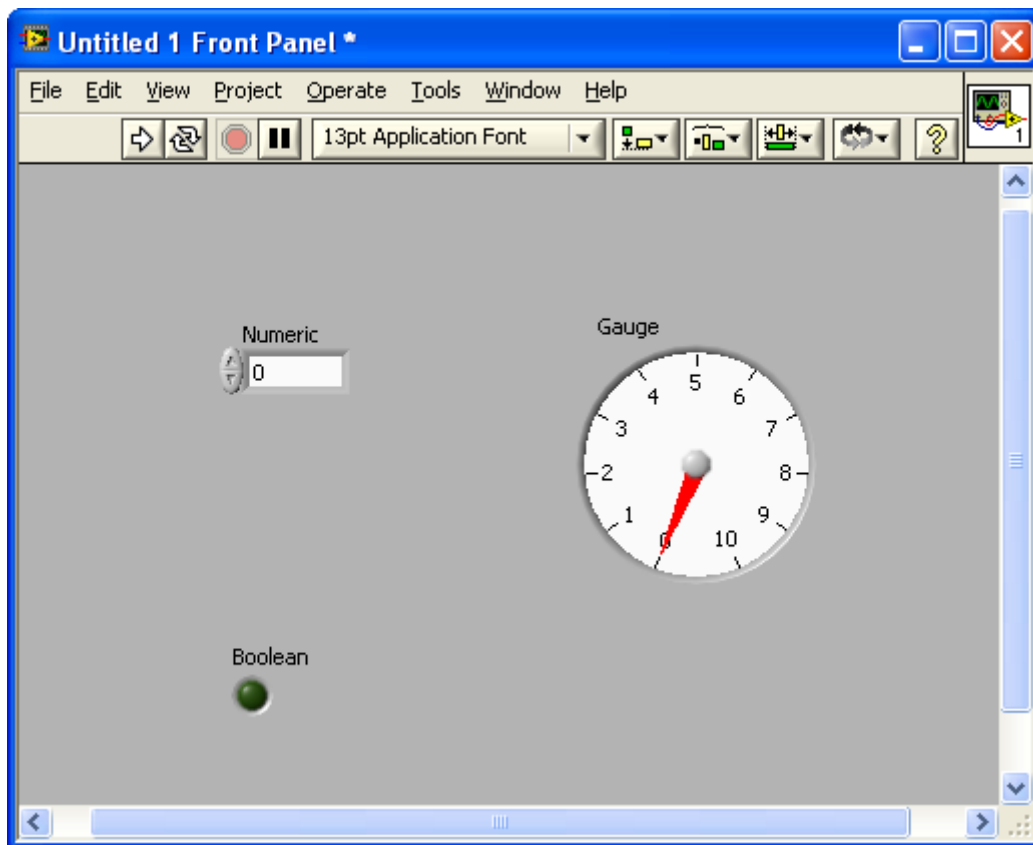

In LabVIEW, you build a user interface, or front panel, with controls and indicators. Controls are knobs, push buttons, dials, and other input devices. Indicators are graphs, LEDs, and other displays.

You build the front panel with controls and indicators, which are the interactive input and output terminals of the VI, respectively. Controls are knobs, push buttons, dials, and other input devices. Indicators are graphs, LEDs, and other displays. Controls simulate instrument

input devices and supply data to the block diagram of the VI. Indicators simulate instrument output devices and display data the block diagram acquires or generates.

E.g., a “Numeric” can either be a “Numeric Control” or a “Numeric Indicator”, as seen below.

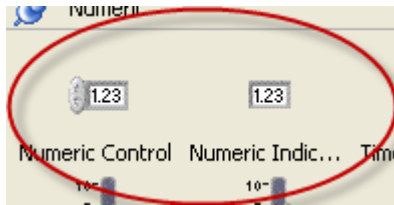

If you select a “Numeric Control”, it can easily be changed to an “Numeric Indicator” by right-clicking on the object and selecting “Change to Indicator”

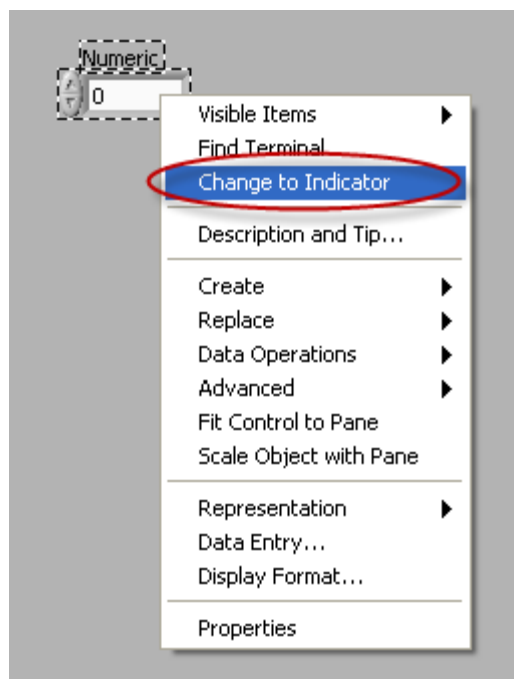

Or opposite, if you select a “Numeric Indicator”, it can easily be changed to an “Numeric Control” by right-clicking on the object and selecting “Change to Control”

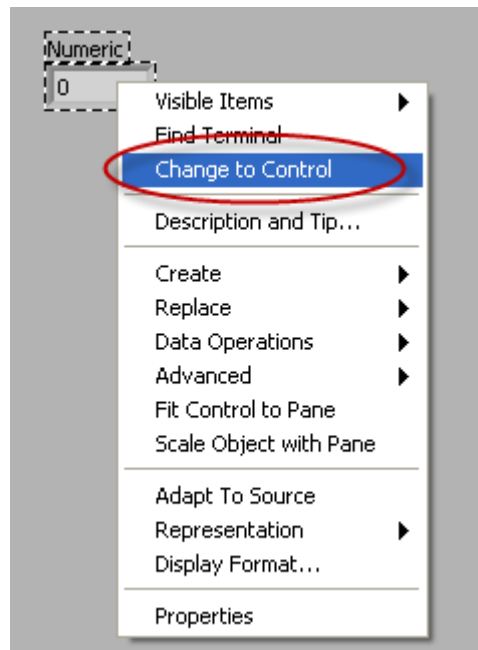

The difference between a “Numeric Control” and a “Numeric Indicator” is that for a “Numeric Control” you may enter a value, while the “Numeric Indicator” is read-only, i.e., you may only read the value, not change it.

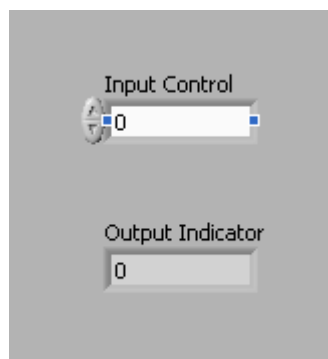

The appearance is also slightly different, the “Numeric Control” has an increment and a decrement button in front, while the “Numeric Indicator” has a darker background color in order to indicate that its read-only.

2.3 Block Diagram

After you build the user interface, you add code using VIs and structures to control the front panel objects. The block diagram contains this code. In some ways, the block diagram resembles a flowchart.

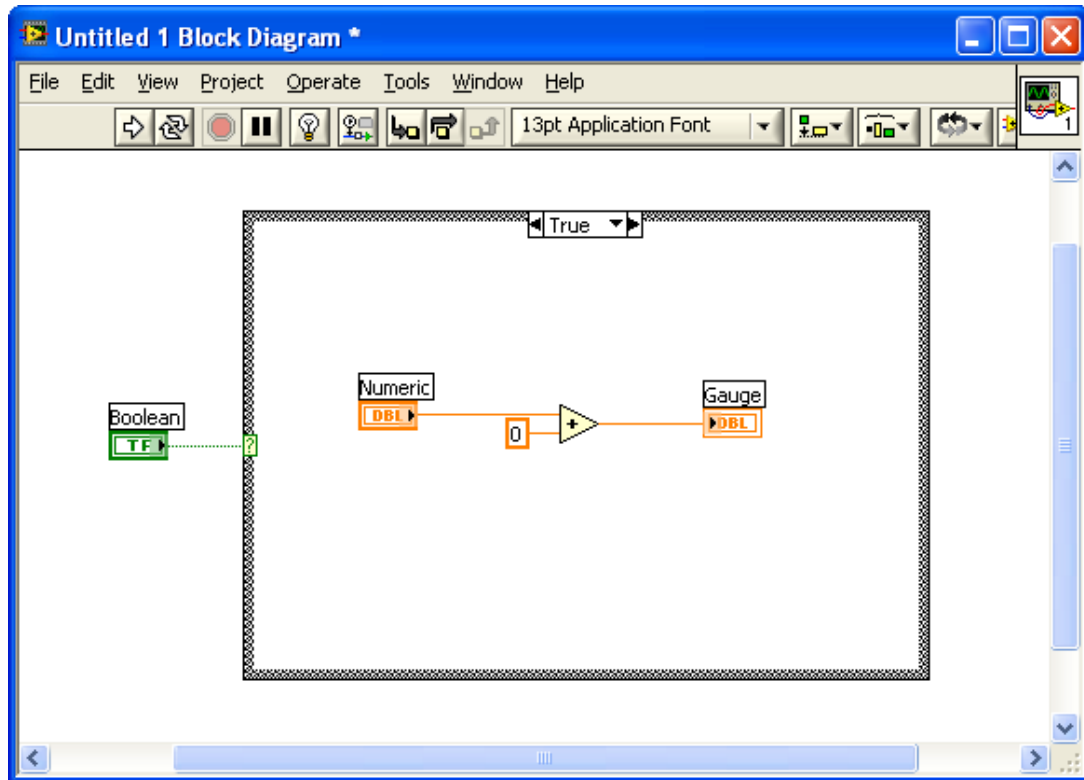

After you build the front panel, you add code using graphical representations of functions to control the front panel objects. The block diagram contains this graphical source code. Front panel objects appear as terminals, on the block diagram. Block diagram objects include terminals, SubVIs, functions, constants, structures, and wires, which transfer data among other block diagram objects.

The Figure below shows a front panel and its corresponding block diagram with front panel and block diagram components.

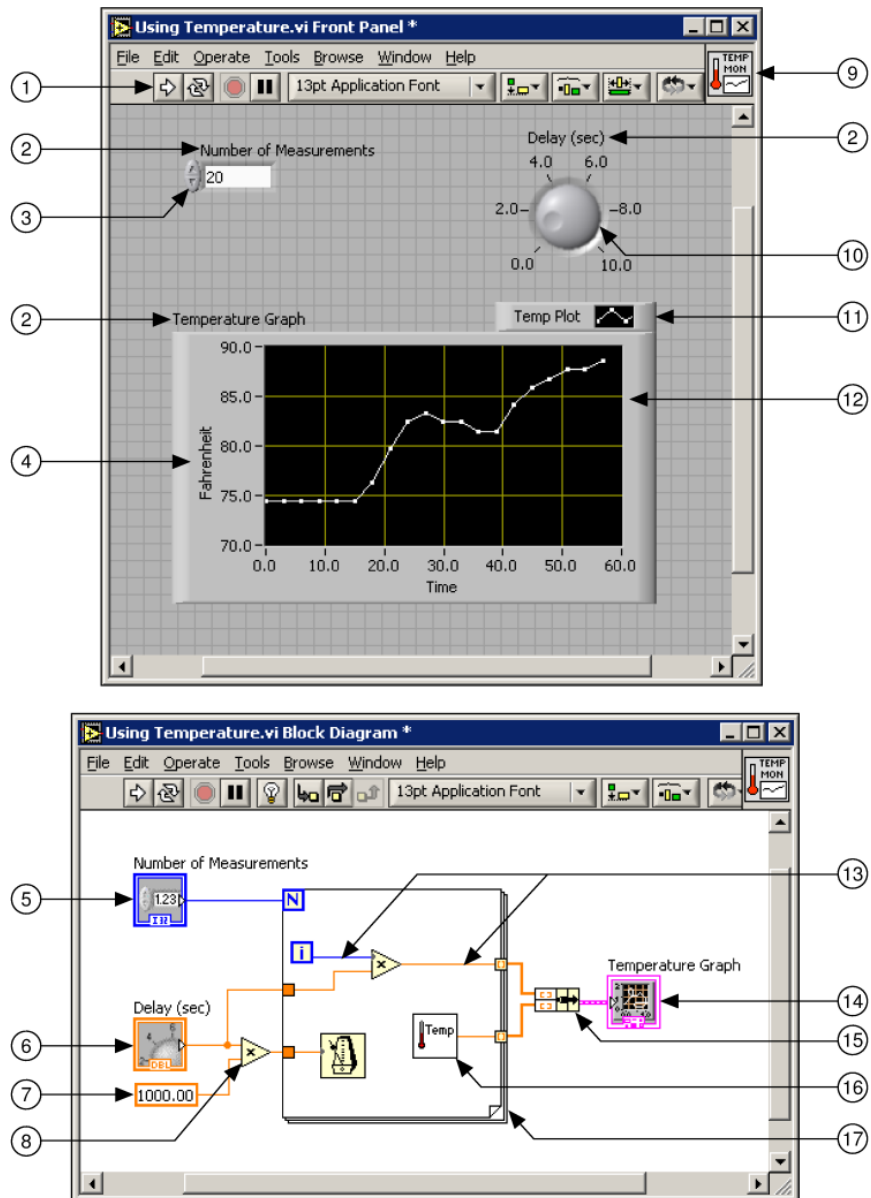

The different components are as follows:

1. Toolbar
2. Owned Label
3. Numeric Control
4. Free Label
5. Numeric Control Terminal
6. Knob Terminal
7. Numeric Constant
8. Multiply Function
9. Icon
10. Knob Control
11. Plot Legend
12. XY Graph

13. Wire Data Path
14. XY Graph Terminal
15. Bundle Function
16. SubVI
17. For Loop Structure

2.4 Controls Palette

The Controls and Functions palettes contain sub palettes of objects you can use to create a VI. When you click a sub palette icon, the entire palette changes to the sub palette you selected. To use an object on the palettes, click the object and place it on the front panel or block diagram. The Controls palette is available only on the front panel. The Controls palette contains the controls and indicators you use to build the front panel.

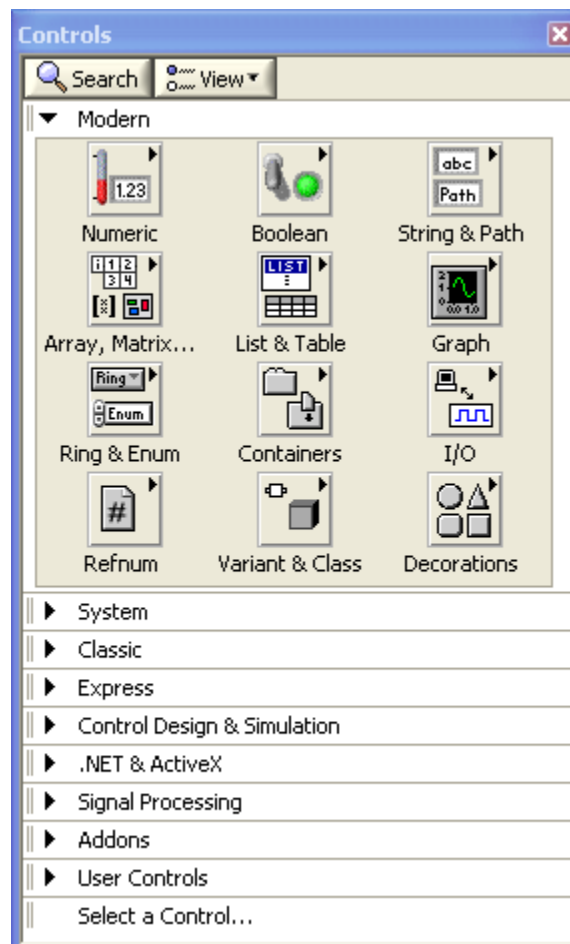

The most used Sub Palettes are the Numeric Sub Palette, the Boolean Sub Palette and the String & Path Sub Palette.

You may change the appearance and the contents of the Controls palette:

You may Pin the palette, so it is always visible, just click the little pin button  in the upper left corner of the palette:



If you want to change the content and appearance of the palette, click the “View” button.

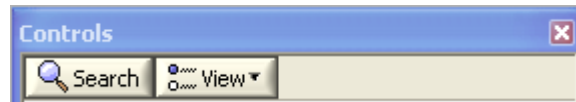

Here you may change the way the palette should look.

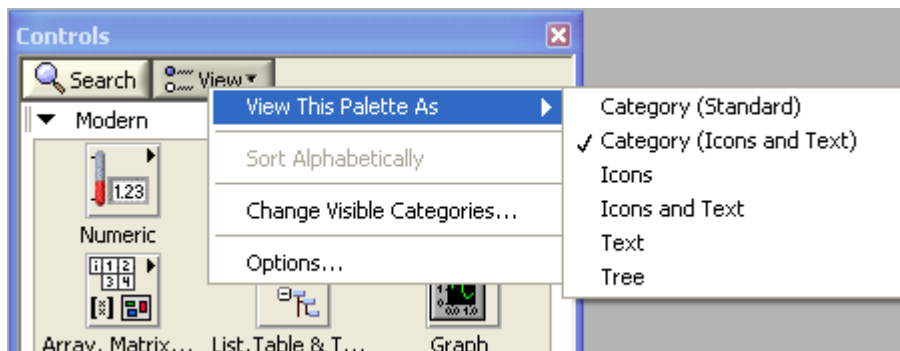

If you click “Change Visible Categories...” you may change which Categories you want to have visible.

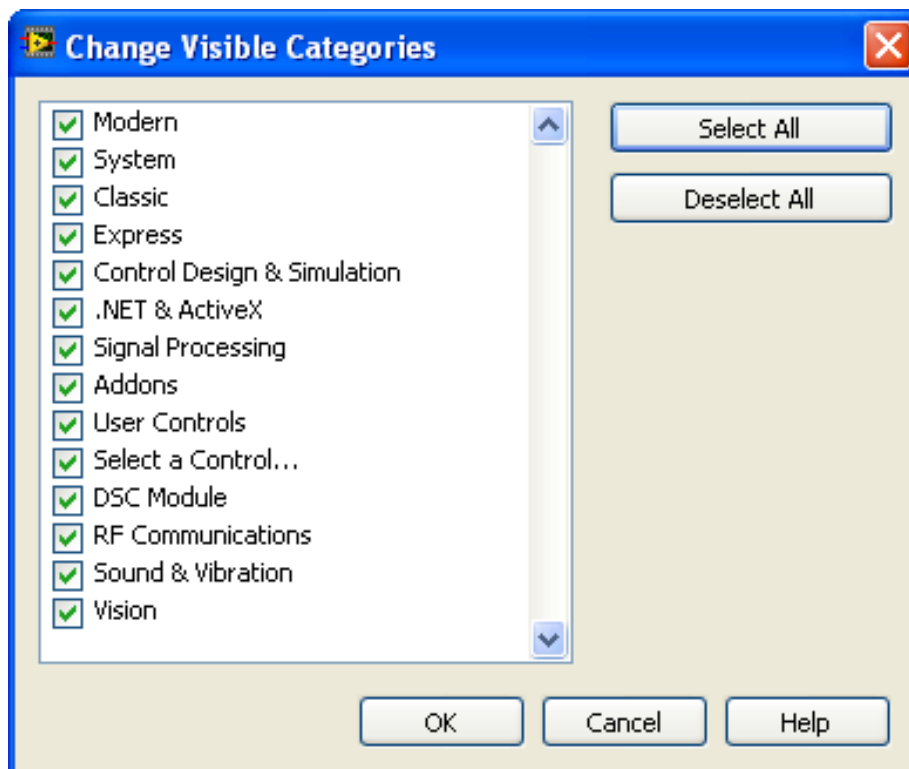

2.4.1 Numeric Sub Palette

“Numerical Control” and “Numerical Indicator” are the most used objects in the numeric sub palette.

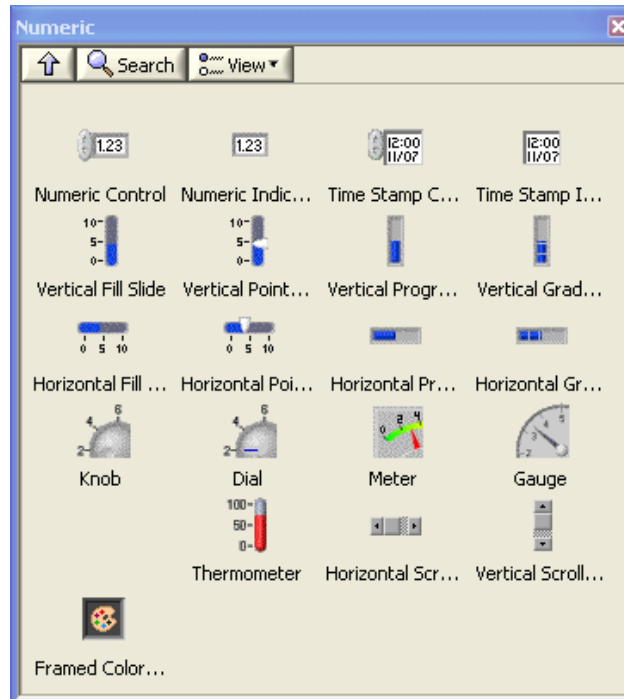

2.4.2 Boolean Sub Palette

This palette has lots of different buttons you may use. OK, Cancel and Stop buttons are useful.

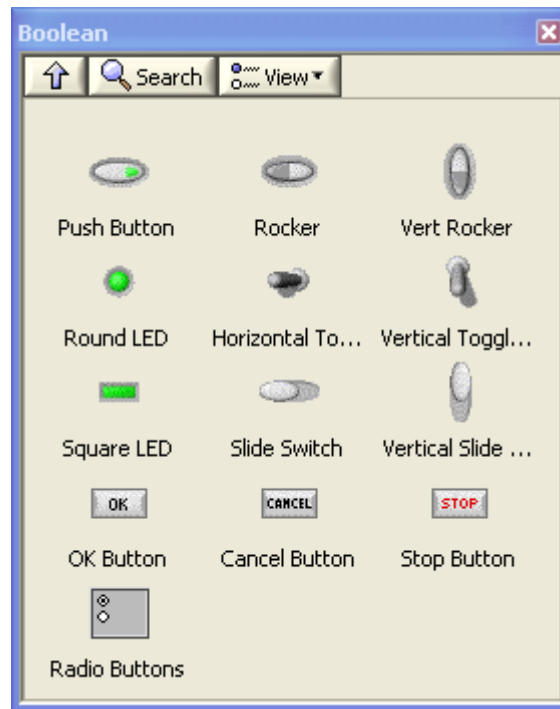

2.4.3 String & Path Sub Palette

In the String and Path palette we have String Controls, Combo Box, etc.

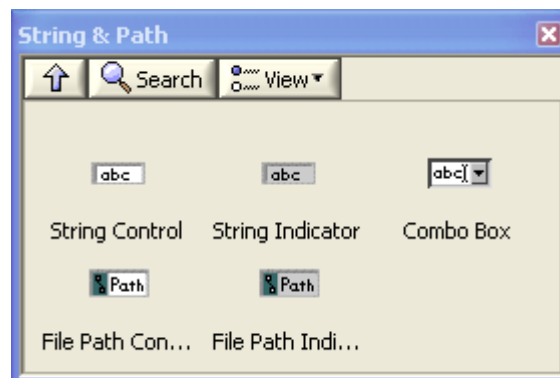

2.5 Function Palette

The Functions palette is available only on the block diagram. The Functions palette contains the VIs and functions you use to build the block diagram.

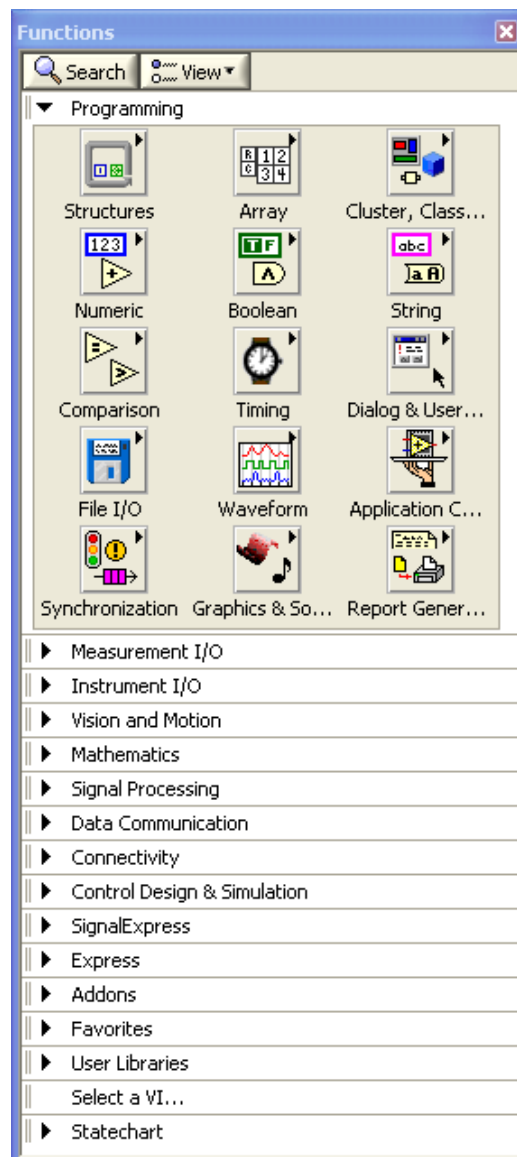



2.6 Tools Palette

You can create, modify, and debug VIs using the tools located on the floating Tools palette. The Tools palette is available on both the front panel and the block diagram. A tool is a special operating mode of the mouse cursor. The cursor corresponds to the icon of the tool selected in the Tools palette. Use the tools to operate and modify front panel and block diagram objects.

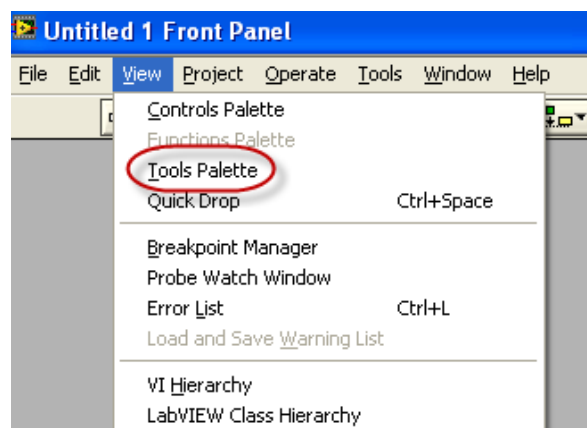

The Tools palette is available from the View menu:



 If you make sure “Automatic wiring” is disabled (I recommend you do so!) you may use the **Tab** key on your keyboard in order to switch between the most common tools.

The most used tools are:



Use the **Operating tool**, shown at left, to change the values of a control or select the text within a control. The Operating tool changes to the icon shown at left when it moves over a text control, such as a numeric or string control.



Use the **Positioning tool**, shown at left, to select, move, or resize objects. The Positioning tool changes to resizing handles when it moves over the edge of a resizable object.



Use the **Labeling tool**, shown at left, to edit text and create free labels. The Labeling tool changes to the following icon  when you create free labels.



Use the **Wiring tool**, shown at left, to wire objects together on the block diagram.

2.7 Wiring

In order to create the logical flow between the object on the Block Diagram, you need to use the Wiring tool in order to connect the different objects together.



Use the Wiring tool to wire objects together on the block diagram.

Available Keyboard Shortcuts when dealing with Wiring:

Wiring	
Ctrl-B	Removes all broken wires.
Esc, right-click, or click terminal	While wiring, cancels a wire you started.
Single-click wire	Selects one segment.
Double-click wire	Selects a branch.
Triple-click wire	Selects entire wire.
A	While wiring, disables automatic wire routing temporarily.
Double-click	While wiring, tacks down wire without connecting it.
spacebar	While wiring, switches the direction of a wire between horizontal and vertical.
spacebar	While moving objects, toggles automatic wiring.
Ctrl-click input on function with two inputs	Switches the two input wires.
Shift-click	While wiring, undoes last point where you set a wire.



Ctrl-B is very useful. This short-cut removes all broken wires on the Block Diagram.

2.8 Toolbar

Below we see the LabVIEW Toolbar:





The behaviors of the different buttons are as follows:

 Click the Run button to run a VI. LabVIEW compiles the VI, if necessary. You can run a VI if the Run button appears as a solid white arrow. The solid white arrow, shown above, also indicates you can use the VI as a subVI if you create a connector pane for the VI.

 While the VI runs, the Run button appears as shown at left if the VI is a top-level VI, meaning it has no callers and therefore is not a subVI.

 If the VI that is running is a subVI, the Run button appears as shown at left.

 The Run button appears broken, shown at left, when the VI you are creating or editing contains errors. If the Run button still appears broken after you finish wiring the block diagram, the VI is broken and cannot run. Click this button to display the Error list window, which lists all errors and warnings.

 Click the Run Continuously button, shown at left, to run the VI until you abort or pause execution. You also can click the button again to disable continuous running.

 While the VI runs, the Abort Execution button, shown at left, appears. Click this button to stop the VI immediately if there is no other way to stop the VI. If more than one running top-level VI uses the VI, the button is dimmed.

Note: Avoid using the Abort Execution button to stop a VI. Either let the VI complete its data flow or design a method to stop the VI programmatically. By doing so, the VI is at a known state. For example, place a button on the front panel that stops the VI when you click it.

 Click the Pause button, shown at left, to pause a running VI. When you click the Pause button, LabVIEW highlights on the block diagram the location where you paused execution, and the Pause button appears red. Click the button again to continue running the VI.

2.9 Execution

In addition to the Toolbar buttons above the following Keyboard Shortcuts are available when dealing with Execution:

Execution	
Ctrl-R	Runs the VI.
Ctrl-. [†]	Stops the VI.
Ctrl-M	Changes to run or edit mode.
Ctrl-Run button	Recompiles the current VI.
Ctrl-Shift-Run button	Recompiles all VIs in memory.
Ctrl-↓ [†]	Moves key focus inside an array or cluster.
Ctrl-↑ [†]	Moves key focus outside an array or cluster.
Tab [†]	Navigates the controls or indicators according to tabbing order.
Shift-Tab [†]	Navigates backward through the controls or indicators.
[†] While the VI is running	

2.10 The Objects short-cut menu

The most often-used menu is the object shortcut menu. All LabVIEW objects and empty space on the front panel and block diagram have associated shortcut menus. Use the shortcut menu items to change the look or behavior of front panel and block diagram objects. To access the shortcut menu, right-click the object, front panel, or block diagram.

The Numeric control has the following short-cut/right-click menu:

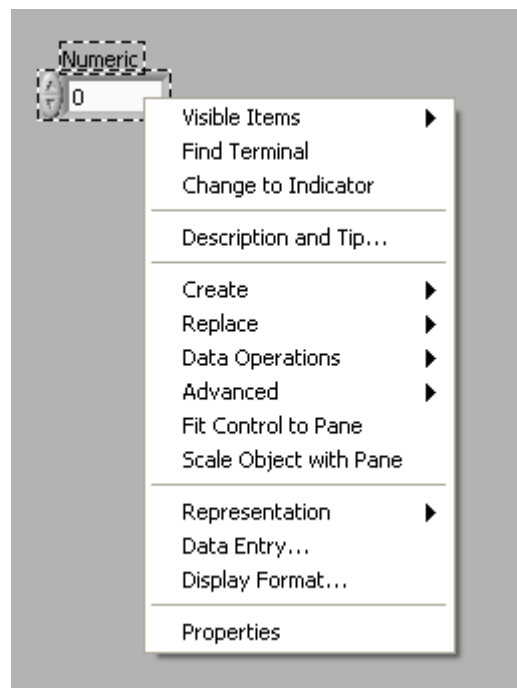

The short-cut menu will be different for the different controls or objects.

2.11 Dataflow Programming

LabVIEW follows a dataflow model for running VIs. A block diagram node executes when all its inputs are available. When a node completes execution, it supplies data to its output terminals and passes the output data to the next node in the dataflow path.

Visual Basic, C++/C#, Java, and most other text-based programming languages follow a control flow model of program execution. In control flow, the sequential order of program elements determines the execution order of a program.

Example: Dataflow Programming

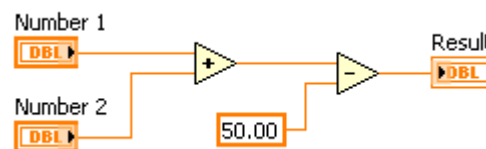

The Example shows a block diagram that adds two numbers and then subtracts 50.00 from the result of the addition. In this case, the block diagram executes from left to right, not because the objects are placed in that order, but because the Subtract function cannot execute until the Add function finishes executing and passes the data to the Subtract function. Remember that a node executes only when data are available at all of its input terminals, and it supplies data to its output terminals only when it finishes execution.

Example: Dataflow Programming

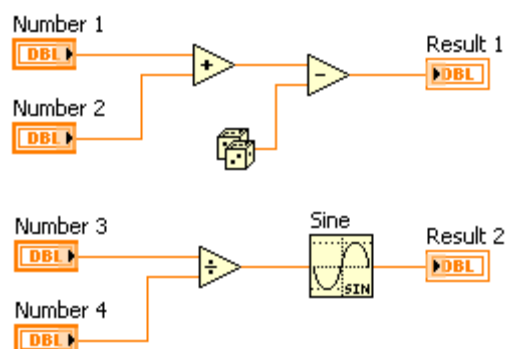

In this example, consider which code segment would execute first—the Add, Random Number, or Divide function. You cannot know because inputs to the Add and Divide functions are available at the same time, and the Random Number function has no inputs. In a situation where one code segment must execute before another and no data dependency

exists between the functions, use other programming methods, such as error clusters, to force the order of execution.

2.12 Help

 The Context Help window (Ctrl +H) displays basic information about LabVIEW objects when you move the cursor over each object. The Context Help window is visible by default. To toggle display of the Context Help window, select Help>Show Context Help, press the Ctrl-H keys, or click the Show Context Help Window button on the toolbar.

When you move the cursor over front panel and block diagram objects, the Context Help window displays the icon for subVIs, functions, constants, controls, and indicators, with wires attached to each terminal. When you move the cursor over dialog box options, the Context Help window displays descriptions of those options. In the window, required connections are bold, recommended connections are plain text, and optional connections are dimmed or do not appear. The Figure below shows an example of the Context Help window.

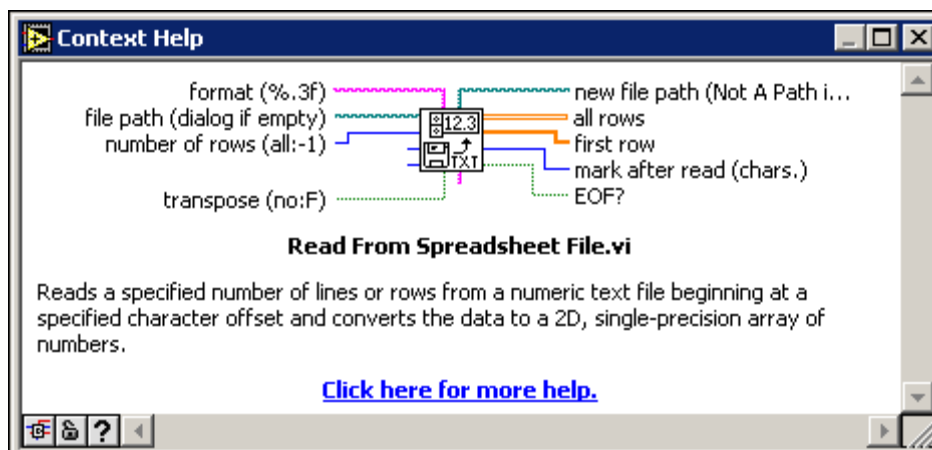

Exercises

Exercise: Create your first LabVIEW application (VI)

Create a simple LabVIEW application (VI) with a Front Panel with some Controls and Indicators. Create the logic by connecting the Terminals on the Block Diagram

The Front Panel could look something like this:

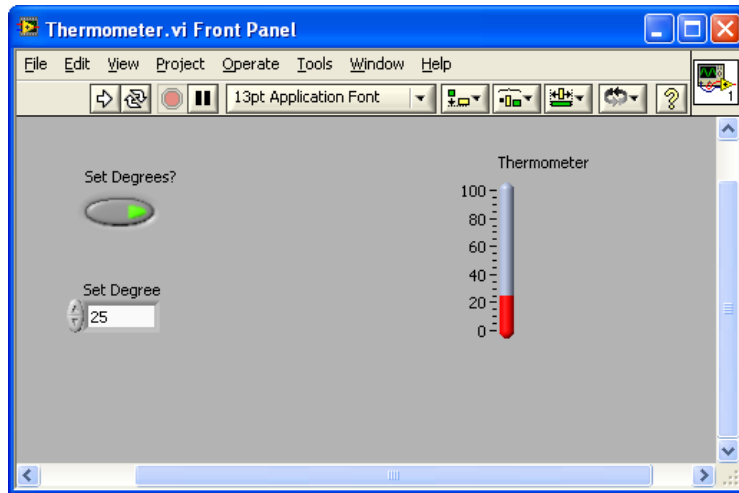

The Block Diagram could look something like this:

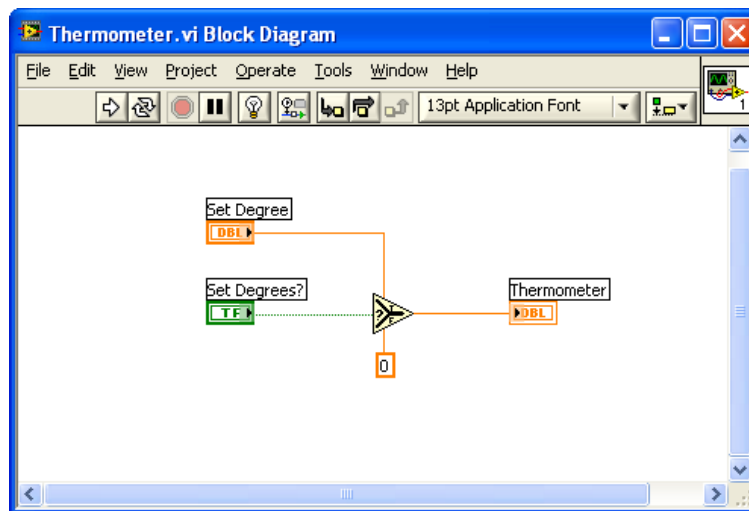

 Start the program with the Run button.

Exercise: Create a simple Calculator

Create a simple calculator that Add and Subtract 2 numbers like this:

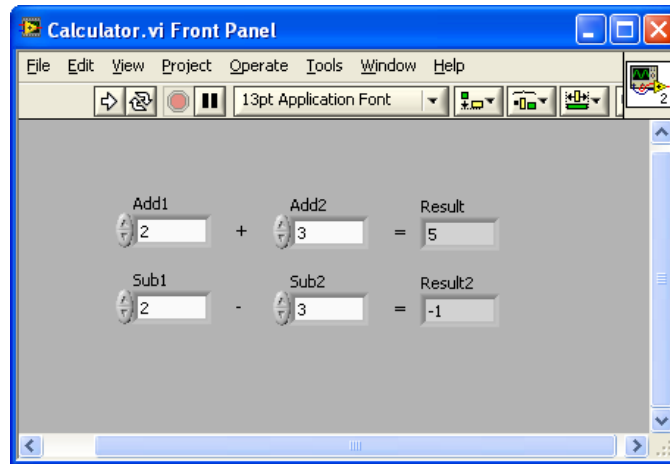

 Start the program with the Run button.

Exercise: Write Data to File

Create a VI that writes data to a Text File.

Use Vis or functions from the File I/O palette

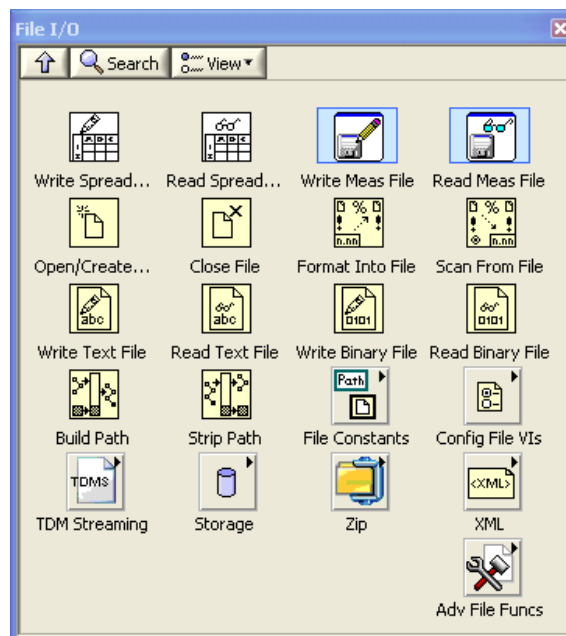

The program could look something like this:

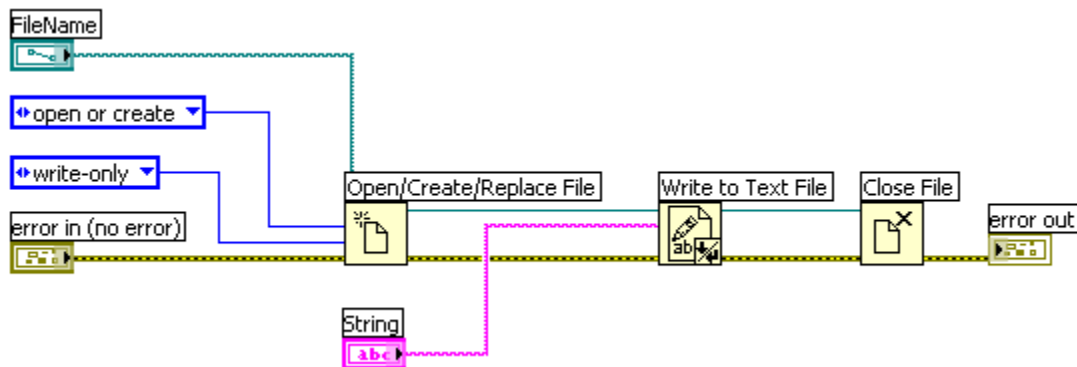
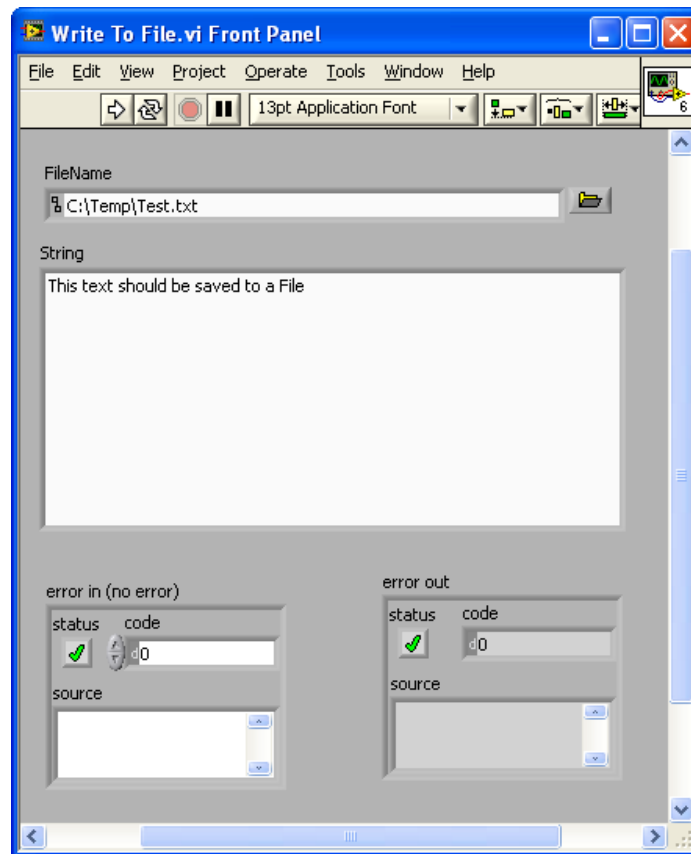

Exercise: Read Data from File

Create another VI that read the text file you created in the previous VI.

3 Sub VIs

This chapter explains the basic concepts of creating and using Sub VIs in LabVIEW.

Topics:

- Create New Sub VI from Scratch
- Create Sub VI from existing code
- Using Sub VIs

When you place a VI on the block diagram, LabVIEW considers the VI to be a subVI. When you double-click a subVI, its front panel and block diagram appear, rather than a dialog box in which you can configure options. The front panel includes controls and indicators. The block diagram includes wires, front panel icons, functions, possibly subVIs, and other LabVIEW objects. The upper right corner of the front panel and block diagram displays.

Below we see an example of a bad Block Diagram. This example does not make use of the SubVI functionality in LabVIEW at all! This makes the Block diagram hard to read and understand. The size of the diagram is also too large! The Block Diagram should always fit into the screen. Both the Front Panel and the Block Diagram should fit into a screen resolution of 1024x768.

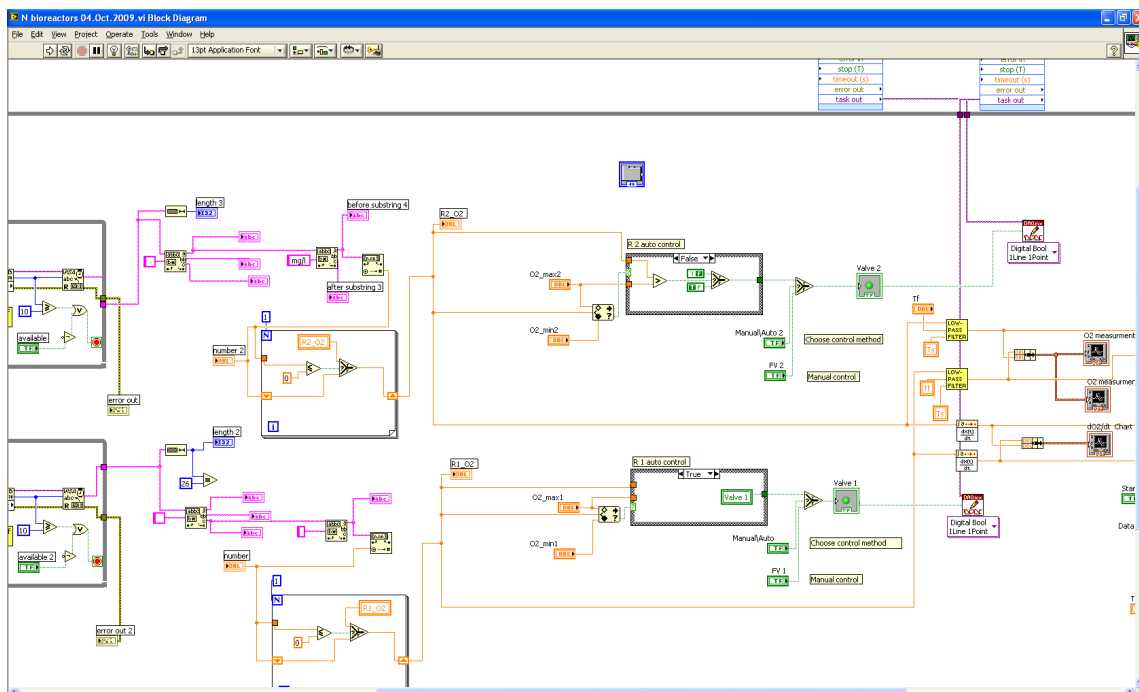

With use of SubVIs, the example above could turn into, e.g.:

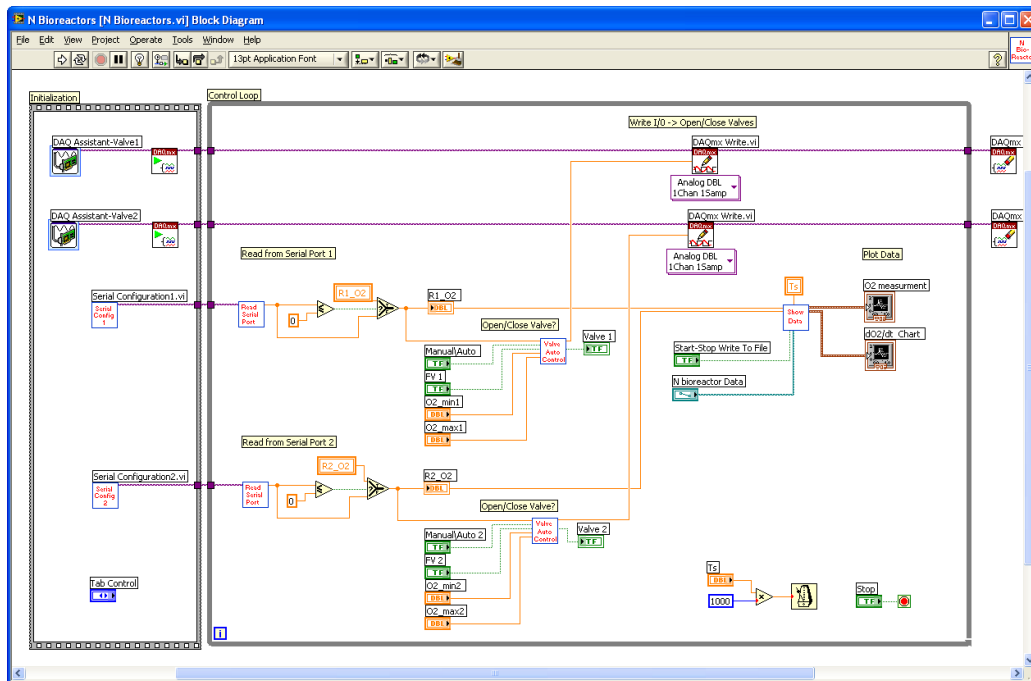

As you can see, much of the code in the Main VI have been replaced and put into SubVIs. The program is now more readable.

Another approach is to use a so-called State Machine principle (more about this in chapter 11 - Design Techniques).

Available Keyboard Shortcuts when dealing with Sub VIs:

SubVIs	
Double-click subVI	Displays subVI front panel.
Ctrl-double-click subVI	Displays subVI block diagram and front panel.
Drag VI icon to block diagram	Places that VI as a subVI on the block diagram.
Shift-drag VI icon to block diagram	Places that VI as a subVI on the block diagram with constants wired for controls that have non-default values.
Ctrl-right-click block diagram and select VI from palette	Opens the front panel of that VI.

3.1 Create New Sub VI from Scratch

Select “Blank VI” in the “Getting Started” window when opening LabVIEW, or when LabVIEW is already opened select File → New V” or use the short-cut Ctrl+N.

3.1.1 Input and Output SubVI Connectors

Most SubVIs will have input and output “connectors”. This is similar with functions or methods in other programming language that have input arguments and an output/result.

In order to create connectors, Right-click on the icon in the upper right corner of the VI and select “Show Connector”.

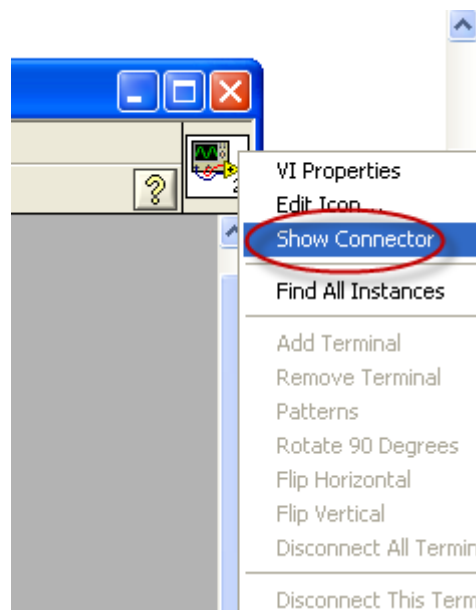

You may select different Patterns, i.e., how many input and output connectors you need.

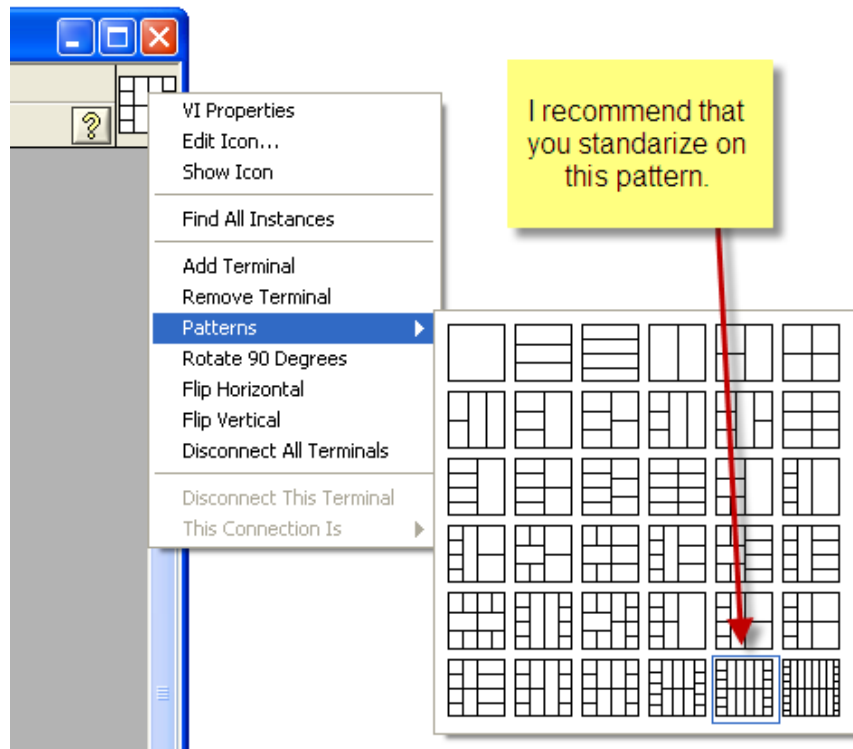

Make sure you select a Pattern with enough connectors even if you don't need all the connectors at the moment. I recommend that you standardize on the pattern in the Figure above.



Select the Wire tool and click on the wanted connector, then click on the Control or Indicator on the Front Panel you want to connect to this connector.



You should always follow these connector rules:

- Upper left connector: "Reference" In
- Upper right connector: "Reference" Out
- Lower left connector: Error In Cluster
- Lower right connector: Error Out Cluster

Example: SubVI Connectors

See example below about these connector rules:

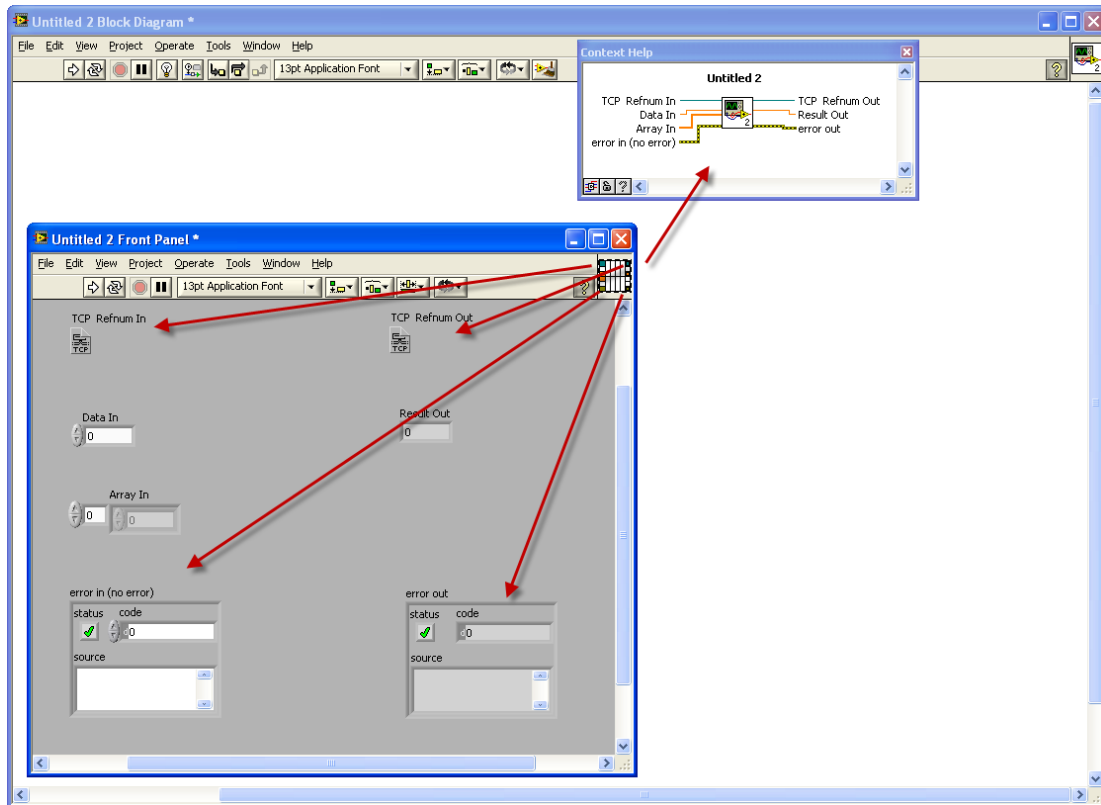

Most common VIs that exits follow these rules, see example below.

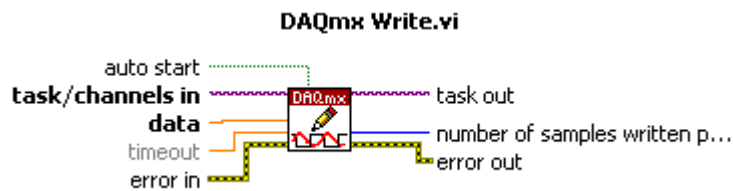

If you follow these connector rules it's much easier to create a clean and neat code like this:



By doing this it's also clear how the Data flows in the program. It should always flow from left to right.

3.1.2 Icon Editor

You should also create a suitable icon for your SubVI.

In order to open the Icon Editor, double-click on the icon in the upper right corner of your VI.

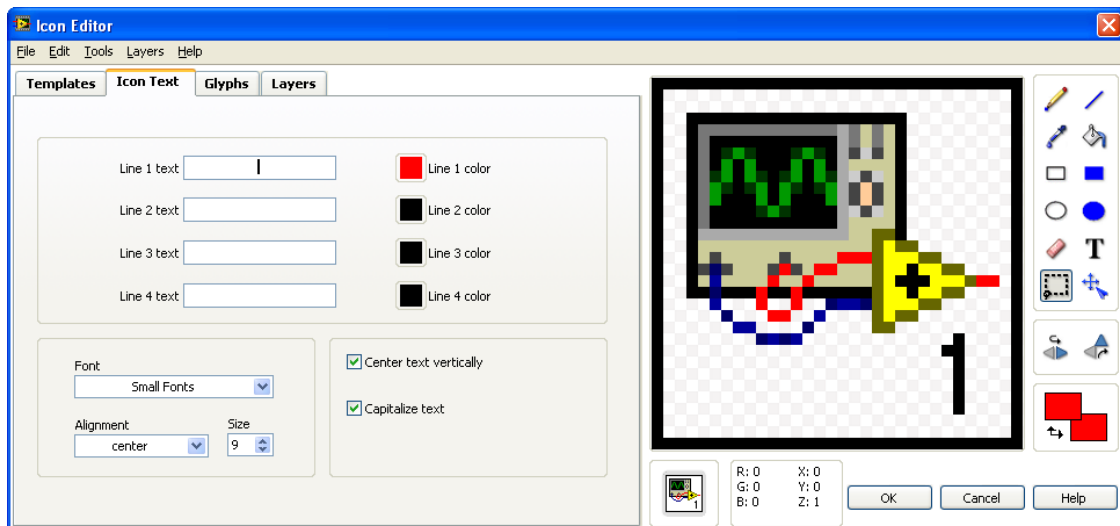

Below we see a block diagram with SubVIs icon appearance created with the Icon Editor.

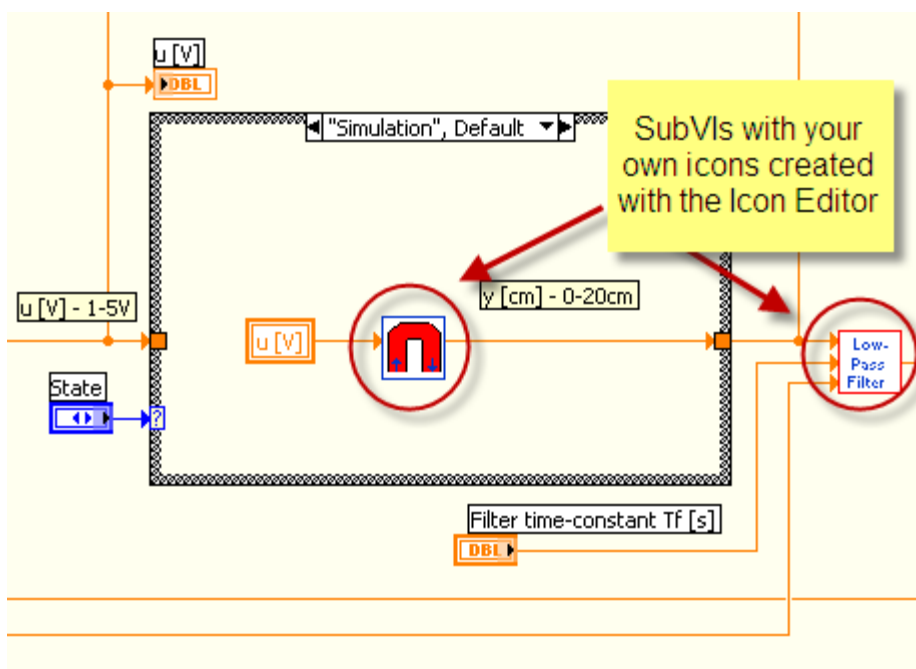

3.2 Create Sub VI from existing code

If you find out that your code is getting messy, you could consider putting some code into a SubVI.

The procedure is as follows:

1. Select the part of your code you want to turn into a SubVI
2. From the Edit menu, select "Create SubVI"

3. LabVIEW will automatically create a SubVI for the selected code.
4. Clean up automatically created wires, etc.
5. Create a suitable icon for your SubVI

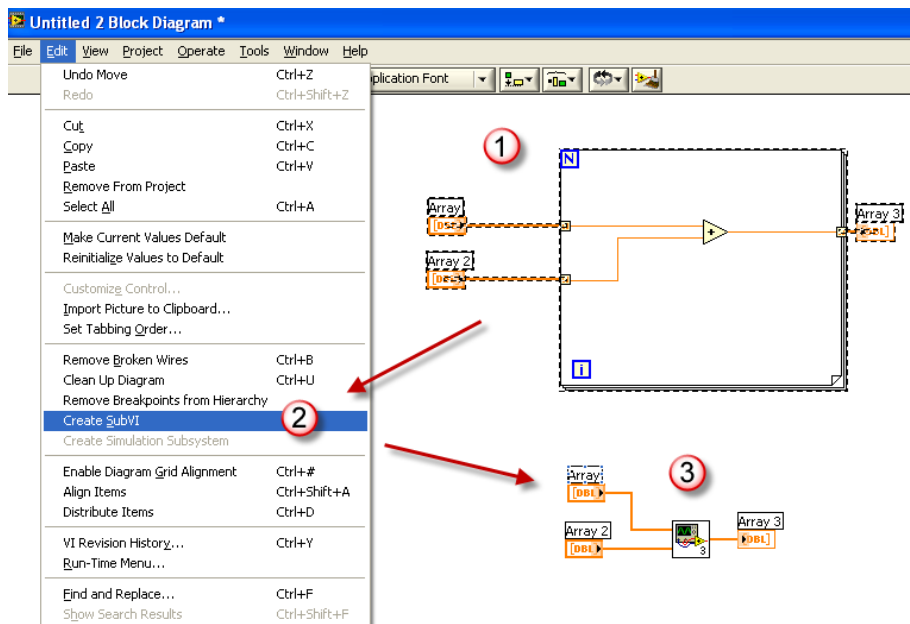

Although this is quite easy to do this, I do not recommend that you use this functionality to much. This is because you should create and use SubVIs from the first moment you start creating your application and not afterwards when you find out that you have been creating a messy code.

So you should structure and design your code with the use of SubVIs from the beginning!

3.3 Using Sub VIs

Below we see an example of how to use SubVIs in a program (Top VI or SubVIs):



You may open a SubVI from the File menu, select a SubVI from the Functions palette or use drag and drop in different ways, e.g., you may drag a VI from the File Explorer in Windows directly into an existing VI you have already opened in LabVIEW

Exercises

Exercise: Convert C to F VI

Create a SubVI that convert a Temperature in Celsius to a Temperature in Fahrenheit



1. Create the SubVI
2. Create the Front Panel and the Block Diagram as shown above
3. Create necessary Connectors
4. Create a suitable icon, e.g.:

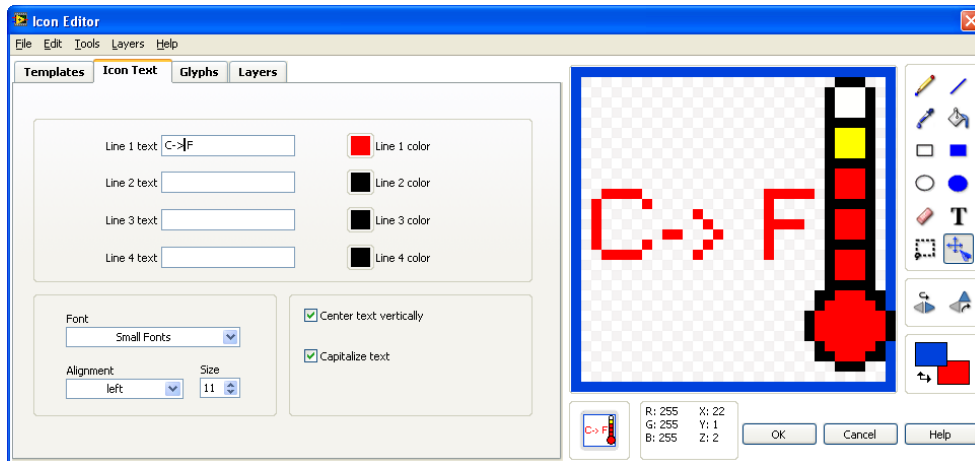

5. Use the SubVI in another VI
6. Run the program to see if it works
7. Expand the program so you can select if you want to convert from Celsius to Fahrenheit or from Fahrenheit to Celsius

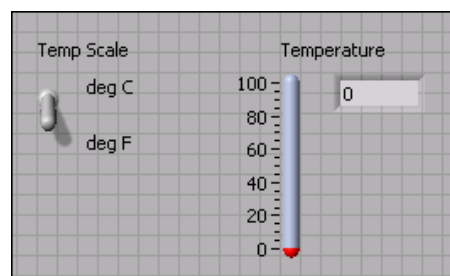

Exercise: Convert existing code into a SubVI

Convert a part of your application into a SubVI by using the Create SubVI function in LabVIEW.

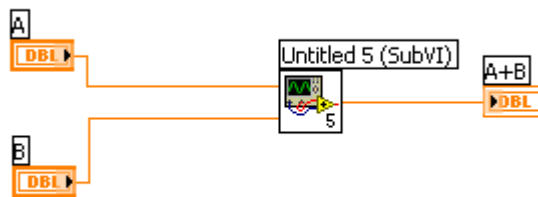
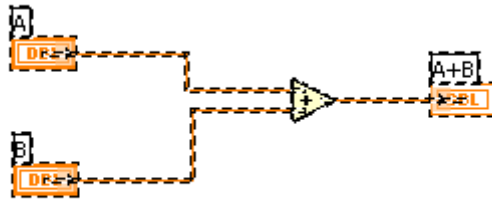

4 Customize LabVIEW

LabVIEW has lots of possibilities for customizing the appearance and the use of the LabVIEW environment. Select “Options...” from the Tools menu.

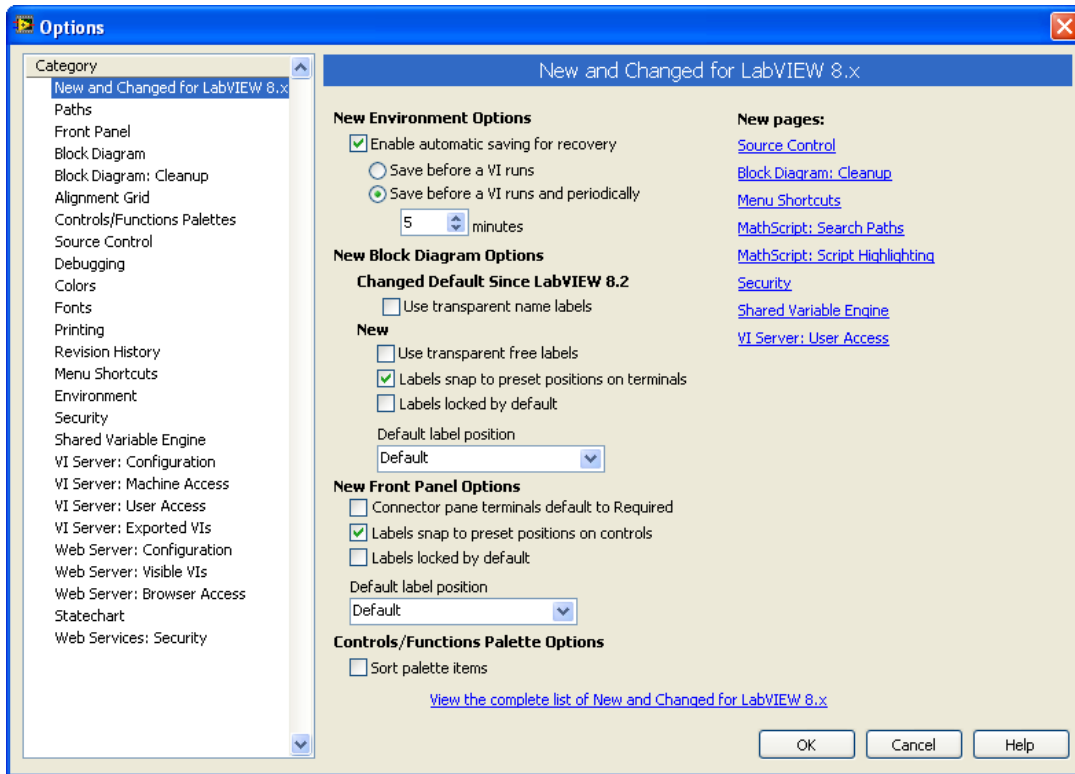

The default settings is not necessary the best, here are some recommendations for setting up the LabVIEW environment.

Category: Block Diagram

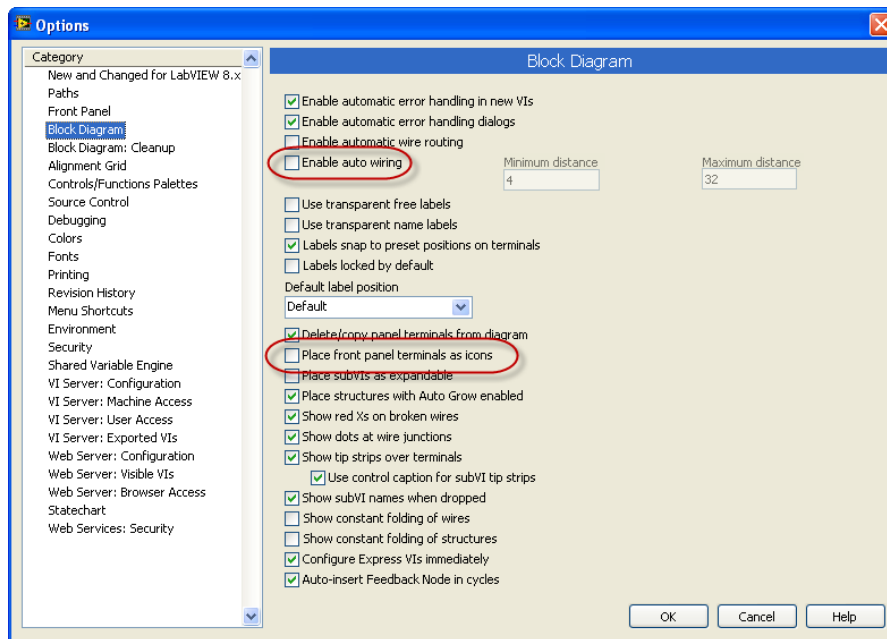

- Disable “*Enable auto wiring*” option. This prevents LabVIEW from automatically connecting adjacent blocks. Although it seems useful to have auto wiring enables, it is my experience that the auto wiring is a little annoying since it tends to draw wires between blocks when you do not want any wire.
- Disable “*Place front panel elements as icons*” option. This causes LabVIEW to use small terminal icons on the block diagram. If you, instead, activate this option, the terminal icons are larger, with a mimic of the element as it appears at the front panel.

Category: Controls/Functions Palettes

- In the Format list: select “*Category (Icons and Text)*”

Category: Alignment Grid

- Turn off “*Show Front Panel Grid*” and “*Show Block Diagram Grid*”

Exercises

Exercise: Customize LabVIEW

Try the different settings explained in this chapter. Turn them on and off and watch the different.

5 Loops and Structures

This chapter explains the basic concepts of Loops and Structures in LabVIEW.

The topics are as follows:

- For Loop
- While Loop
- Case Structure
- Sequence Structure
- Event Structure

The different Loops and Structures available are located in the “*Structures*” sub palette in the Functions palette on the Block Diagram.

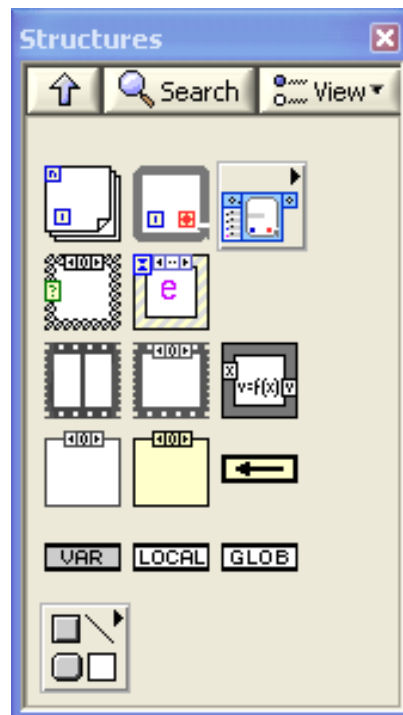

5.1 Loops

The most important loops are:

- **For** Loop
- **While** Loop

These loops will be explained in detail below.

5.1.1 For Loop

A For Loop executes a sub diagram a set number of times. The Figure below shows an empty For Loop in LabVIEW.

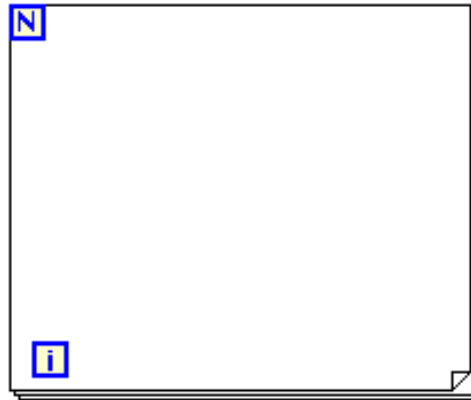

A For loop executes its sub diagram n times, where n is the value wired to the count (**N**) terminal. The iteration (**i**) terminal provides the current loop iteration count, which ranges from 0 to $n-1$.

After you create a For Loop, you can use **shift registers** to pass values from one iteration to the next. If you wire an array to a For Loop, you can read and process every element in that array by enabling **auto-indexing**. You also can enable auto-indexing by configuring a For Loop to return an array of every value generated by the loop.

You can add a **conditional terminal** to configure a For Loop to stop when a Boolean condition or an error occurs. A For Loop with a conditional terminal executes until the condition occurs or until all iterations complete, whichever happens first. To add a conditional terminal to a For Loop, right-click the For Loop border and select Conditional Terminal from the shortcut menu. You must wire the conditional terminal and either wire the count terminal or auto-index an input array for the loop to execute and for the VI to run.

To convert a For Loop to a While Loop, right-click the For Loop and select Replace with While Loop from the shortcut menu.

Example: For Loop

The following example uses a For Loop in order to create an array with 10 elements and fill it with random numbers.

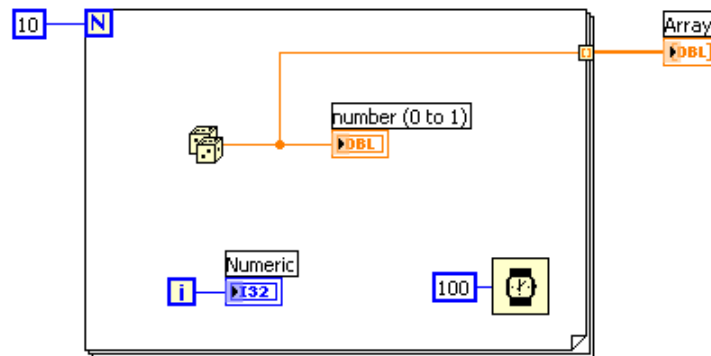

5.1.2 While Loop

A While loop repeats the sub diagram inside it until the conditional terminal, an input terminal, receives a particular Boolean value. The Boolean value depends on the continuation behavior of the While Loop. Right-click the conditional terminal and select **Stop if True** or **Continue if True** from the shortcut menu. You also can wire an error cluster to the conditional terminal, right-click the terminal, and select **Stop on Error** or **Continue while Error** from the shortcut menu. The While Loop always executes at least once.

Below we see an empty While loop:

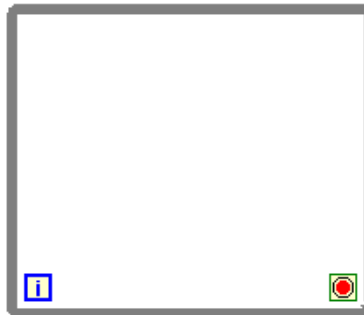

After you create a While Loop, you can use shift registers to pass values from one iteration to the next. If you wire an array to a While Loop, you can read and process every element in that array by enabling auto-indexing.

In order to convert a While Loop into a For Loop, right-click the While Loop and select “Replace with For Loop” from the shortcut menu. To convert a While Loop into a Timed Loop, right-click the While Loop and select “Replace with Timed Loop” from the shortcut menu.

Example: While Loop

This example run until either the user clicks the stop button or number of iterations is greater than 10.

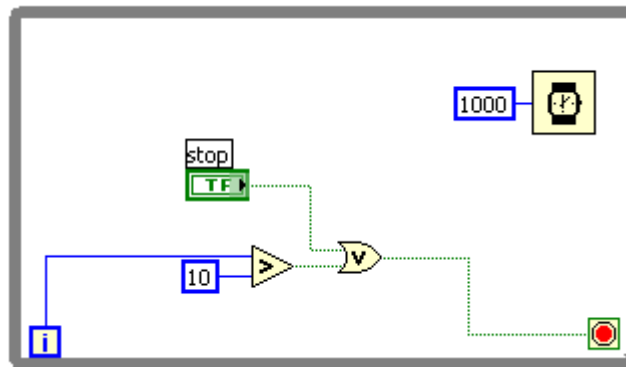

5.2 Structures

5.2.1 Case Structure

The Case Structure has one or more sub diagrams, or cases, exactly one of which executes when the structure executes. The value wired to the selector terminal determines which case to execute and can be Boolean, string, integer, or enumerated type. You may right-click the structure border to add or delete cases. Use the Labeling tool to enter value(s) in the case selector label and configure the value(s) handled by each case.

Below we see an empty Case structure:

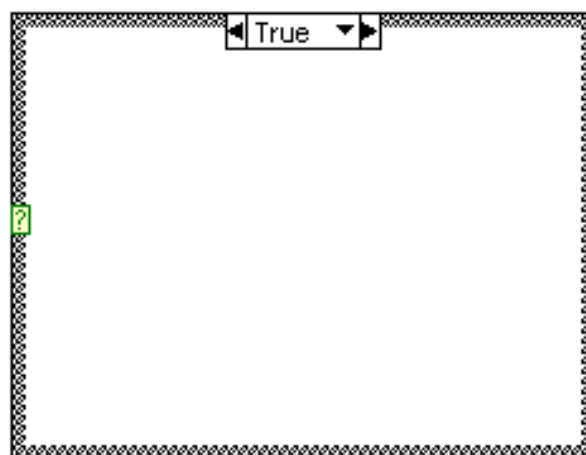

Below we see an example of a Case structure with 2 cases, a “True” case and a “False” case. Depending of the Boolean input value, the Numeric1 and Numeric2 is either Added or Subtracted.

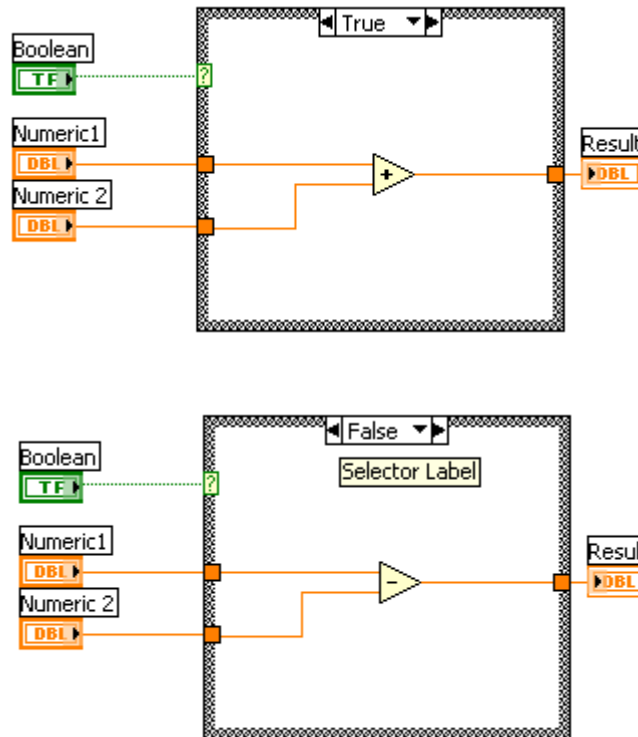

5.2.2 Sequence Structure

A Sequence structure Consists of one or more sub diagrams, or frames, that execute sequentially. Right-click the structure border to add and delete frames or to create sequence locals to pass data between frames. Use the Stacked Sequence structure to ensure a sub diagram executes before or after another sub diagram.

Below we see an empty Sequence structure.

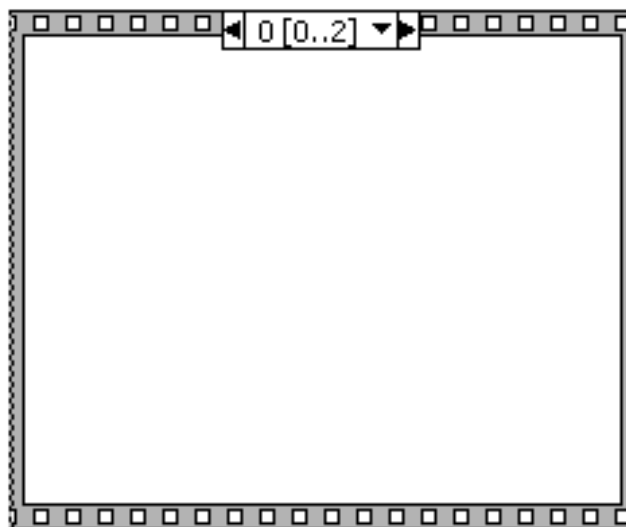

Below we see an example where we use “Sequence Local”, i.e., we pass a value from one

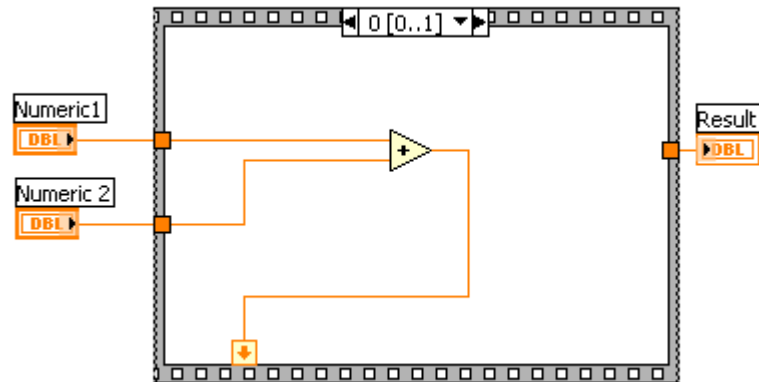

sequence to the next

Note! To take advantage of the inherent parallelism in LabVIEW, avoid overusing Sequence structures. Sequence structures guarantee the order of execution, but prohibit parallel operations. Another negative to using Sequence structures is that you cannot stop the execution part way through the sequence.

5.2.3 Event Structure

An Event structure has one or more sub diagrams, or event cases, exactly one of which executes when the structure executes. The Event structure waits until an event happens, then executes the appropriate case to handle that event. Right-click the structure border to add new event cases and configure which events to handle. Wire a value to the Timeout terminal at the top left of the Event structure to specify the number of milliseconds the Event structure should wait for an event to occur. The default is -1 , indicating never to time out.

Below we see an example:

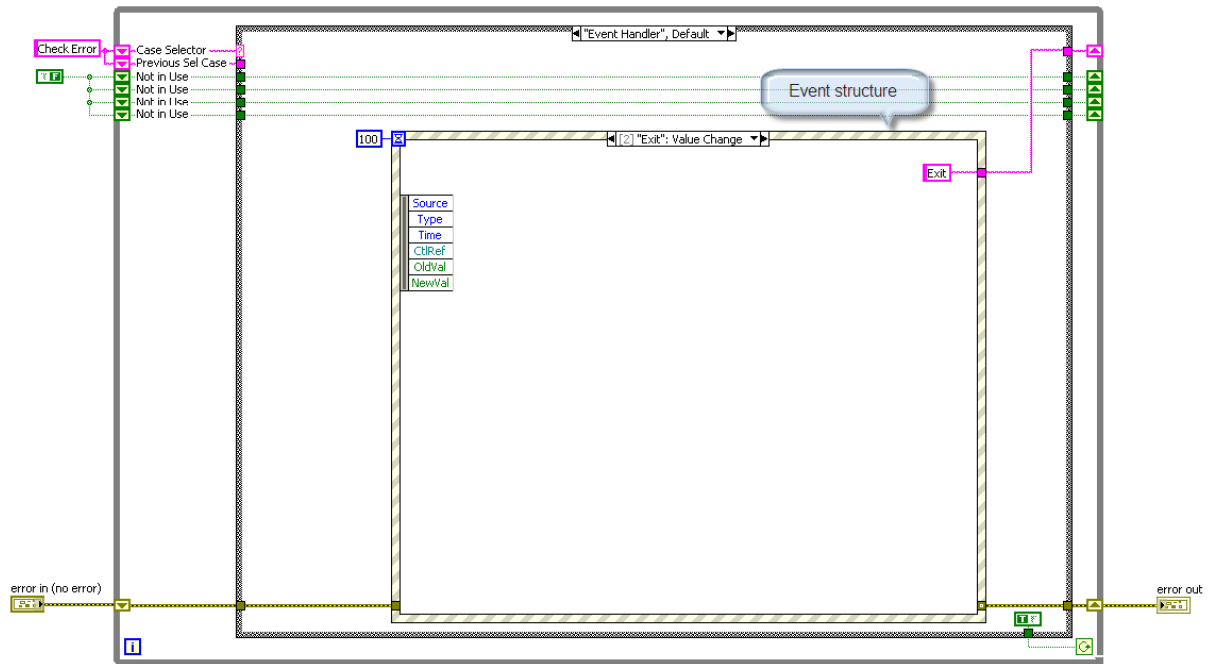

Right-click on the border in order to Add/Edit Event Cases, see the dialog box below.

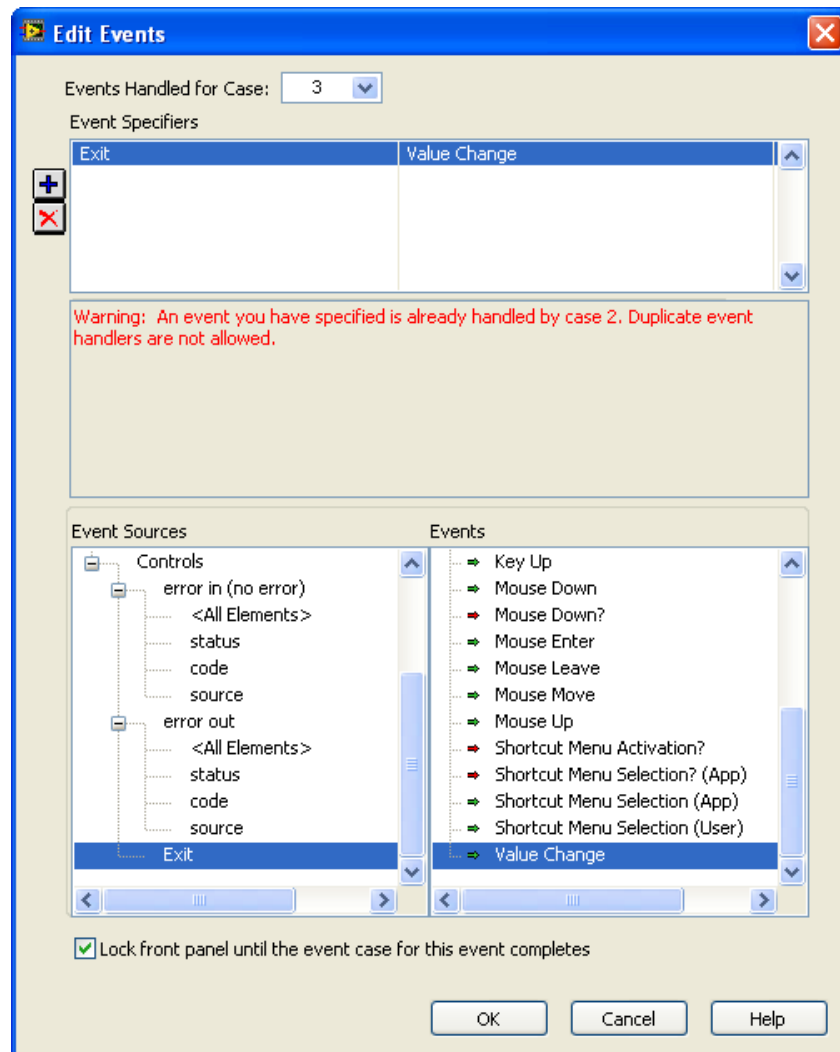

Exercises

Exercise: For Loop

Create a VI with a For Loop. Create the logic to find out if a number in an array is greater than 10. See Front Panel below:

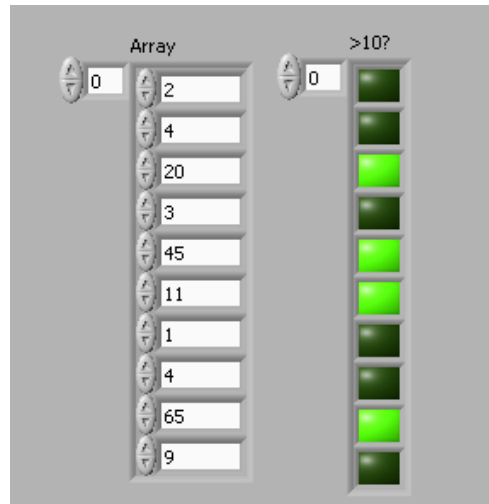

Exercise: While Loop

Create a VI with a While Loop. Create the logic to find out which (the first) index in the array that have a number greater than 30. See Front Panel below:

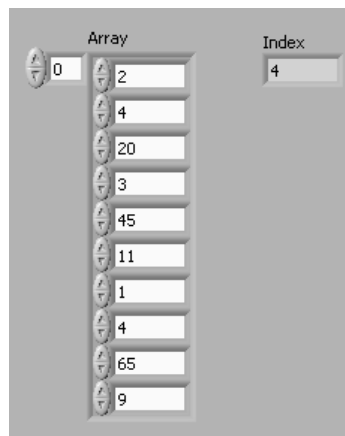

Exercise: Case Structure

Create a VI with a Case Structure.

Use a Case structure inside a For Loop to write the text "The Number is greater than 10" if value is greater than 10. See Front Panel below:

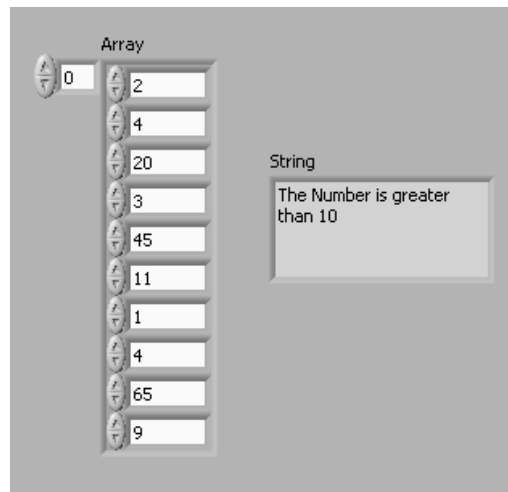

Exercise: Sequence Structure

Create a VI with a Sequence Structure. See Front Panel below:

Exercise: Event Structure

Create a VI with an Event Structure. See Front Panel below:

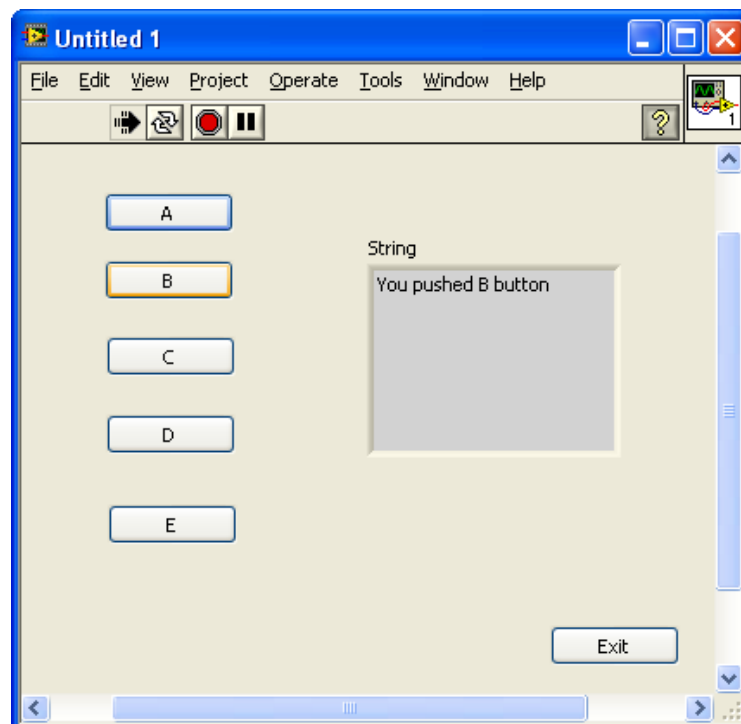

6 Troubleshooting and Debugging

This chapter explains the basic concepts of troubleshooting and debugging in LabVIEW.

Topics:

- How to find errors
- Highlight Execution
- Probes
- Breakpoints
- Step into/over/out debugging

6.1 How to find errors



If a VI does not run, it is a broken, or “nonexecutable”, VI. The Run button often appears broken, shown at left, when you create or edit a VI. If it is still broken when you finish wiring the block diagram, the VI is broken and will not run. Generally, this means that a required input is not wired, or a wire is broken.

Click the broken Run button to display the Error list window, which lists all the errors. Double-click an error description to display the relevant block diagram or front panel and highlight the object that contains the error.

6.2 Highlight Execution



View an animation of the execution of the block diagram by clicking the Highlight Execution button. Execution highlighting shows the flow of data on the block diagram from one node to another using bubbles that move along the wires. Note! Execution highlighting greatly reduces the speed at which the VI runs.

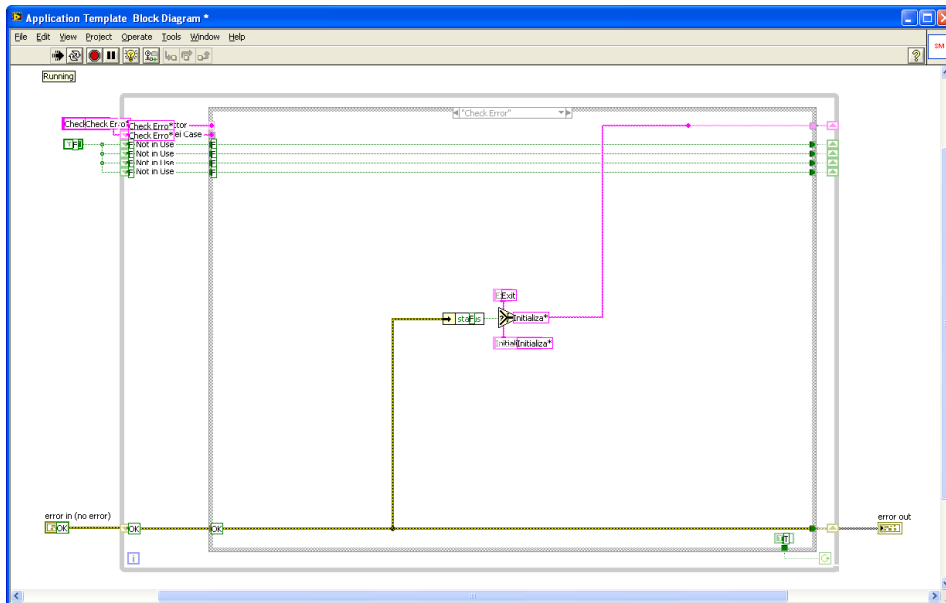

6.3 Probes



Use the Probe tool to check intermediate values on a wire as a VI runs.

When execution pauses at a node because of single-stepping or a breakpoint, you also can probe the wire that just executed to see the value that flowed through that wire. You also can create a custom probe to specify which indicator you use to view the probed data. For example, if you are viewing numeric data, you can choose to see that data in a chart within the probe. To create a custom probe, right-click a wire and select Custom Probe-New from the shortcut menu.

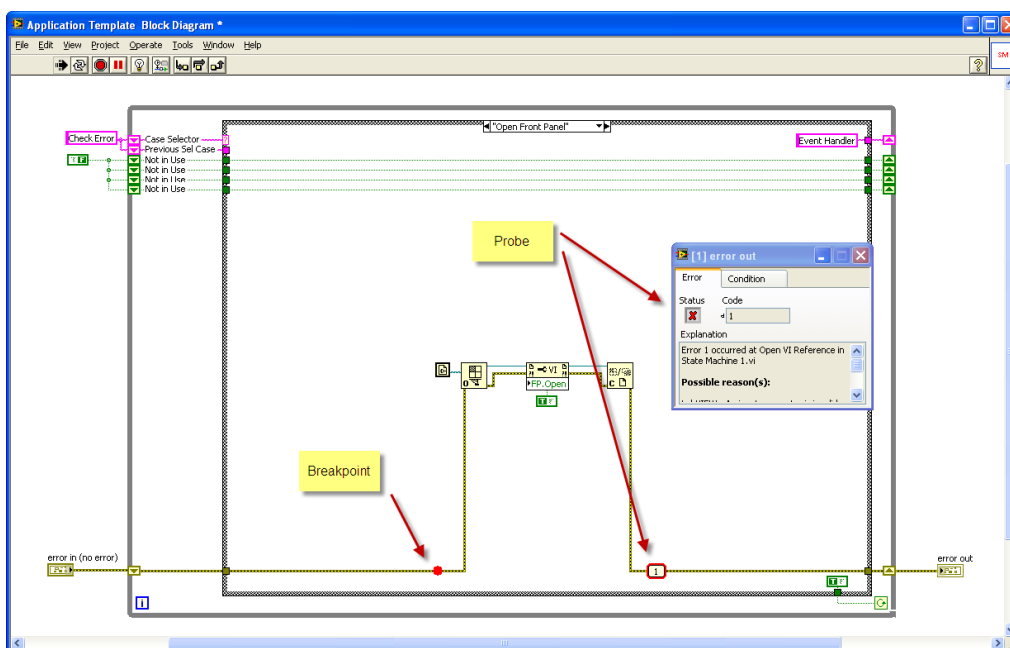

6.4 Breakpoints



 Use the Breakpoint tool to place a breakpoint on a VI, node, or wire on the block diagram and pause execution at that location. When you set a breakpoint on a wire, execution pauses after data pass through the wire. Place a breakpoint on the block diagram workspace to pause execution after all nodes on the block diagram execute. When a VI pauses at a breakpoint, LabVIEW brings the block diagram to the front and uses a marquee to highlight the node or wire that contains the breakpoint. LabVIEW highlights breakpoints with red borders for nodes and block diagrams and red bullets for wires. When you move the cursor over an existing breakpoint, the black area of the Breakpoint tool cursor appears white. Use the Breakpoint tool to click an existing breakpoint to remove it.

You may also right-click on the wire in order to set a breakpoint or open the Breakpoint Manager.

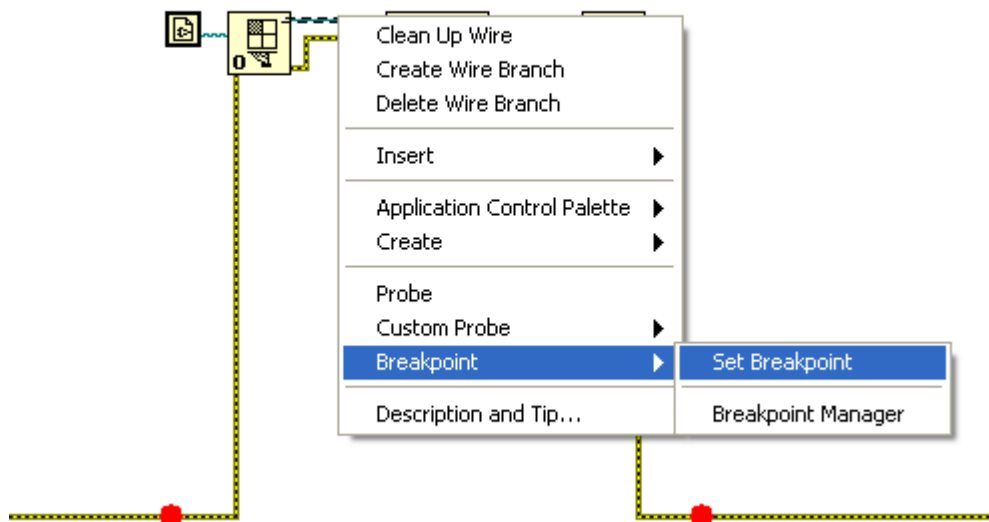

Breakpoint Manager is a tool for enable, disable and delete breakpoints.

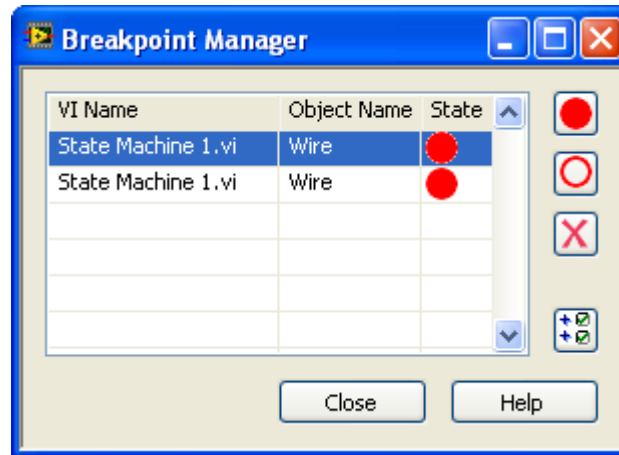

6.5 Step into/over/out debugging

Available Keyboard Shortcuts when Debugging:

Debugging	
Ctrl-↓	Steps into node.
Ctrl-→	Steps over node.
Ctrl-↓	Steps out of node.

Exercises

Exercise: Highlight Execution

Enable “Highlight Execution” in one of your programs, and see how it works.

Exercise: Probes

Set Several Probes around in your application and watch how it works. Use the Probe watch Window and check out the functionality this tool offers.

Also check out the “Custom Probe” and the “Find Probe” functionality.

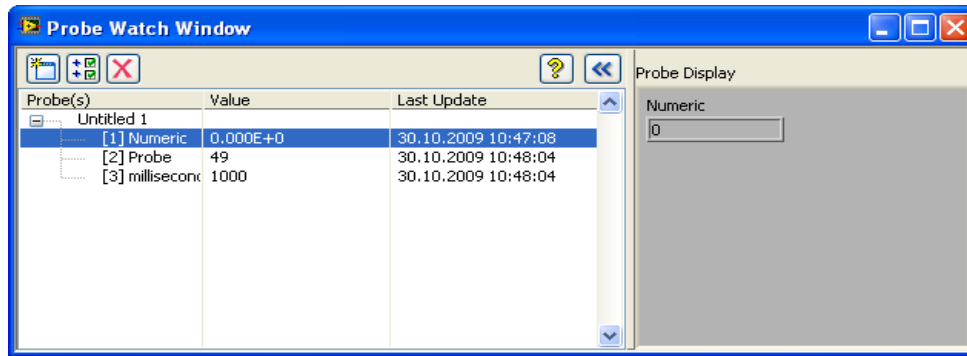

Exercise: Breakpoints

Set some Breakpoint around in your code and check out how it works. Use the Breakpoint Manager tool.

Example:

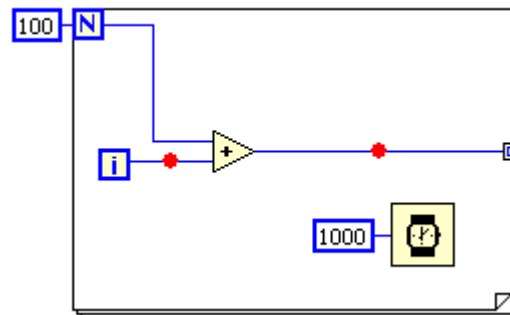

Exercise: Step into/over/out debugging

Use the Step into/over/out functionality together with your Breakpoints and learn how you can use them and see what the difference between them is.

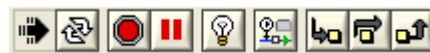

7 Working with Data

This chapter explains the basic concepts of creating and using Sub Vis in LabVIEW.

Topics:

- Arrays
- Array Functions
- Cluster

7.1 Arrays

Arrays are very powerful to use in LabVIEW. In all your applications you would probably use both One-Dimensional Arrays and Two-Dimensional Arrays.

7.1.1 Auto-Indexing

LabVIEW uses a powerful mechanism called “Auto-indexing”.

For Example you may use a For loop to create Array data like this:

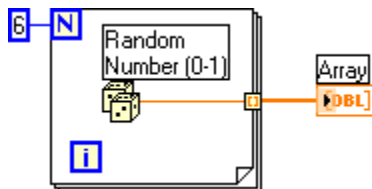

Or you may use an Array like this in order to automatically specify number of iterations:

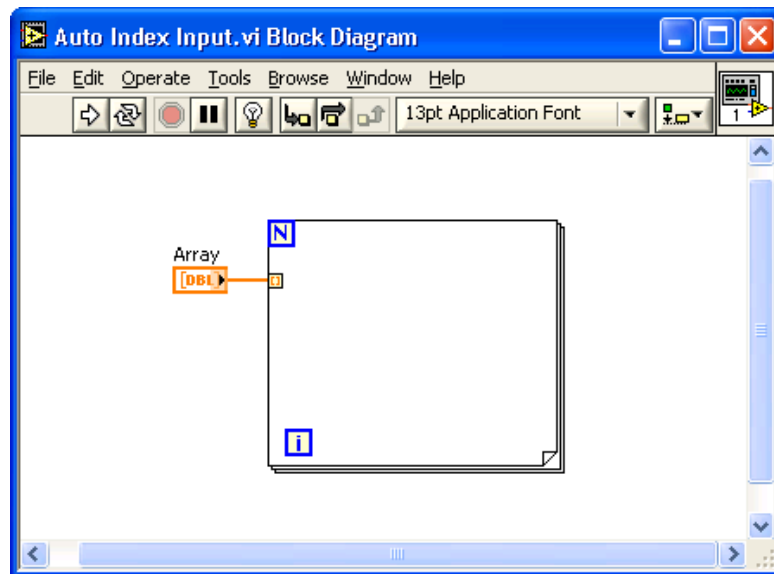

7.1.2 Array Functions

LabVIEW has lots of built-in functions for manipulating arrays.

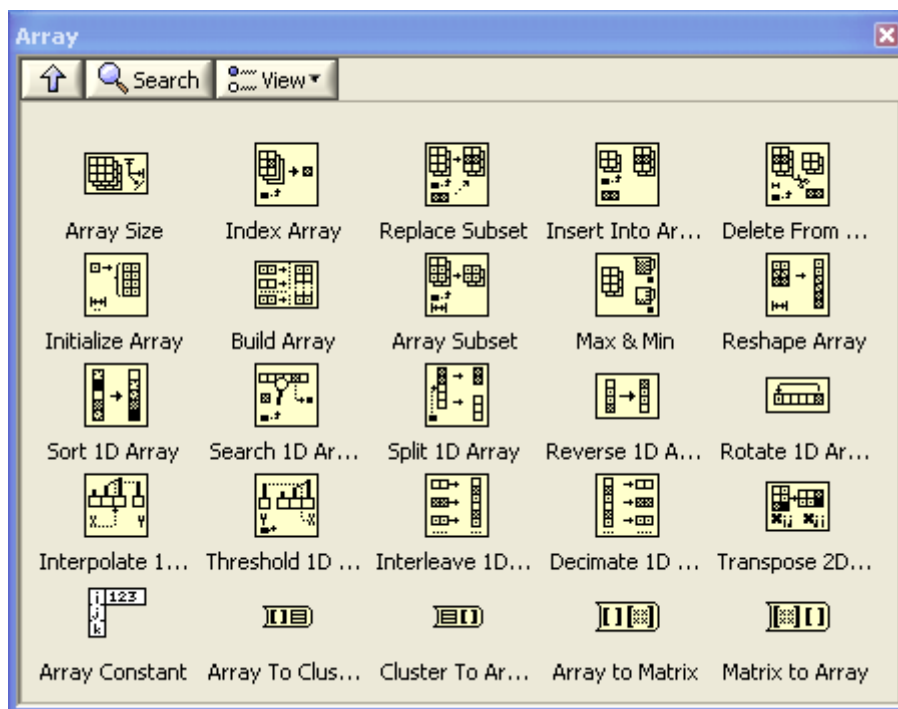

The most useful Array functions are:

 Array Size

 Index Array



Delete from Array



Search 1D Array



Initialize Array



Build Array



Array Subset



Array Constant

All these functions are basic (but very useful) array functions you will probably be using in all your applications and VIs.

Example: Array functions

In this example we see how we can use these Array functions and what they do.

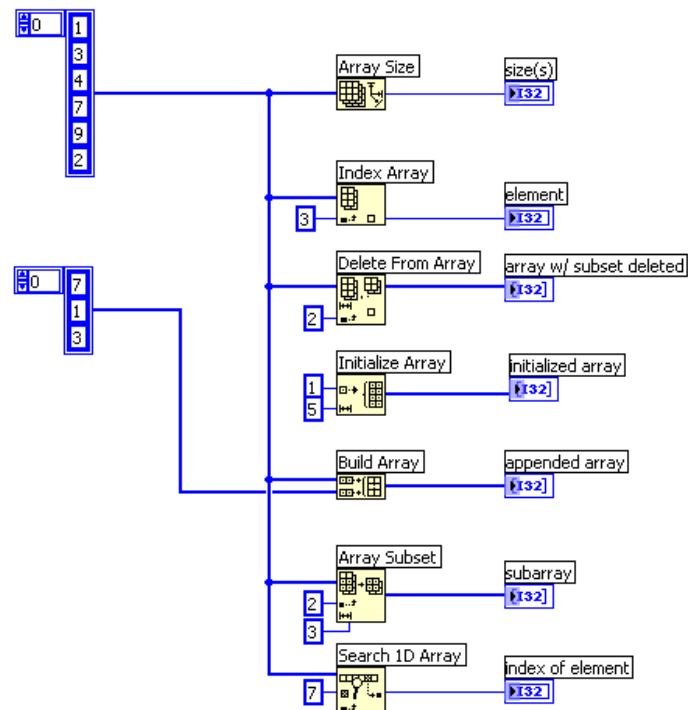

The resulting Front Panel is as follows:

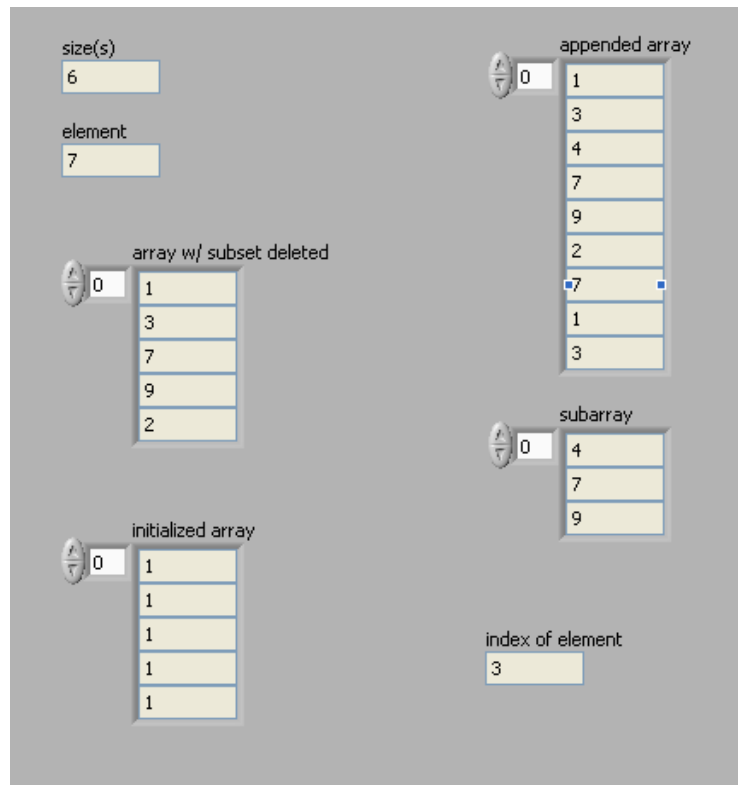

7.2 Cluster

Clusters group data elements of mixed types, such as a bundle of wires, as in a telephone cable, where each wire in the cable represents a different element of the cluster. A cluster is similar to a record or a struct in text-based programming languages. Bundling several data elements into clusters eliminates wire clutter on the block diagram and reduces the number of connector pane terminals that subVIs need. The connector pane has, at most, 28 terminals. If a front panel contains more than 28 controls and indicators that you want to use programmatically, group some of them into a cluster and assign the cluster to a terminal on the connector pane. Like an array, a cluster is either a control or an indicator. A cluster cannot contain a mixture of controls and indicators.

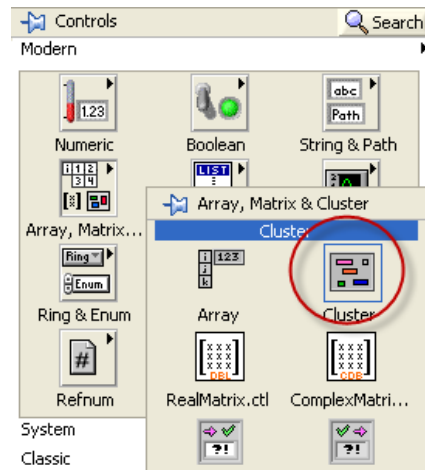

Although cluster and array elements are both ordered, you must unbundle all cluster elements at once rather than index one element at a time. You also can use the “Unbundle By Name” function to access specific cluster elements.

Example of a Cluster in LabVIEW:



7.2.1 Cluster Order

You may sort the different elements in the cluster by right-click on the cluster border and select “Reorder Controls in Cluster...”

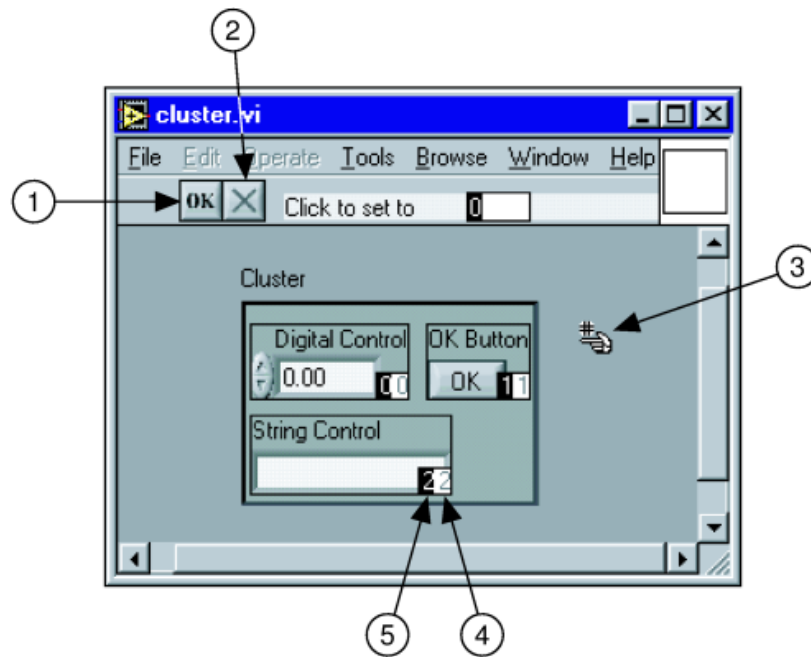

7.2.2 Cluster Elements

In order to manipulate and work with cluster LabVIEW offers lots of functions, such as the “Bundle” and “Unbundle” functions.

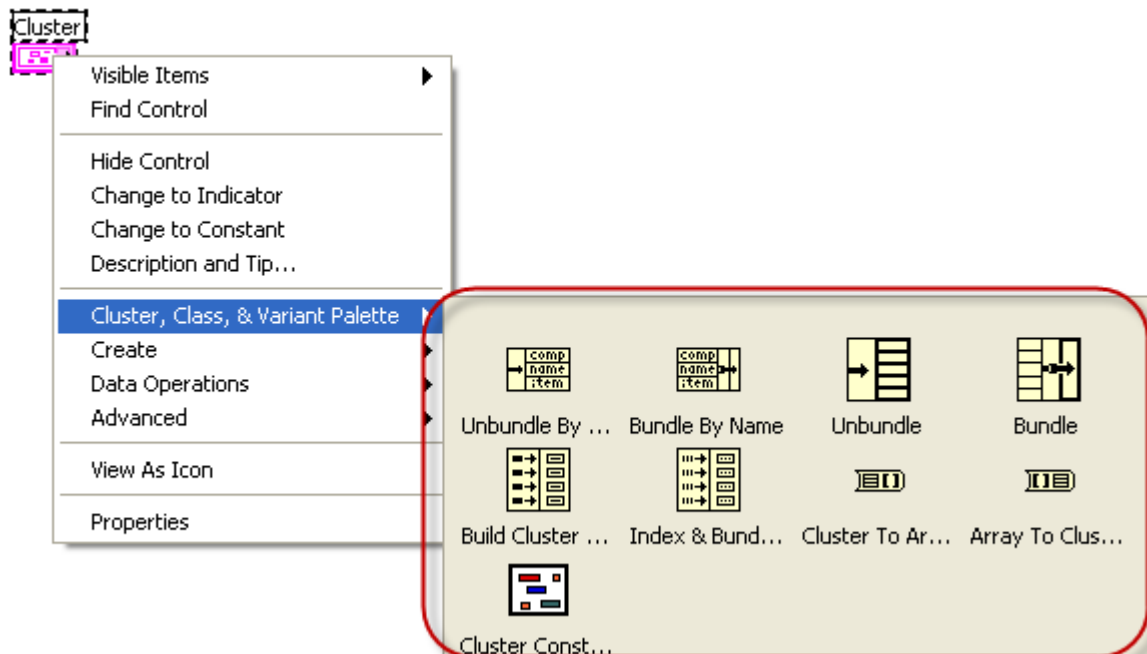

In order to write to a cluster from the code, you may use the “Bundle” function or the “Bundle By Name” function. See example below:

Example: Clusters

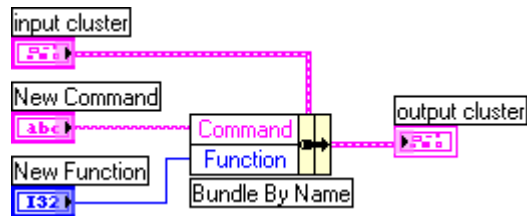



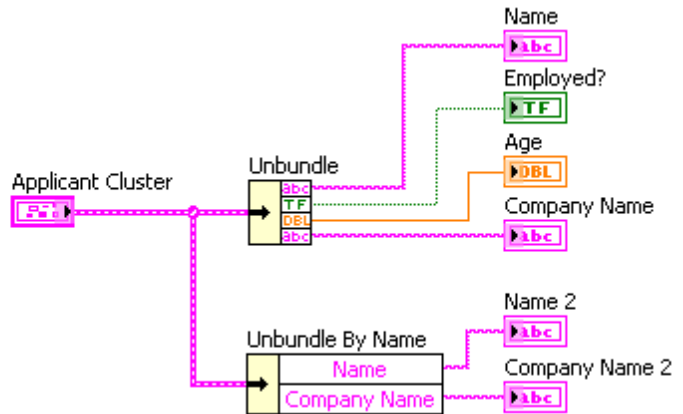



In order to get access to the different elements in the cluster, you need to “Unbundle” by using the “Unbundle” function or the “Unbundle By Name”. See example below:



Exercises

Exercise: Arrays

Create some simple VIs where you use these array functions to manipulate array data:

-  Array Size
-  Index Array
-  Delete from Array
-  Search 1D Array
-  Initialize Array
-  Build Array
-  Array Subset

Exercise: Arrays

Create a SubVI that find the “peaks” in the input array regarding to an input peak level.

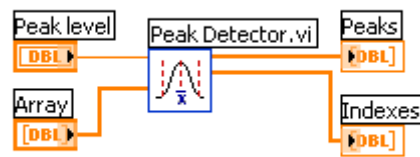

Exercise: Clusters

Create a Cluster and get the different values from the controls in the Cluster. See Front Panel below:

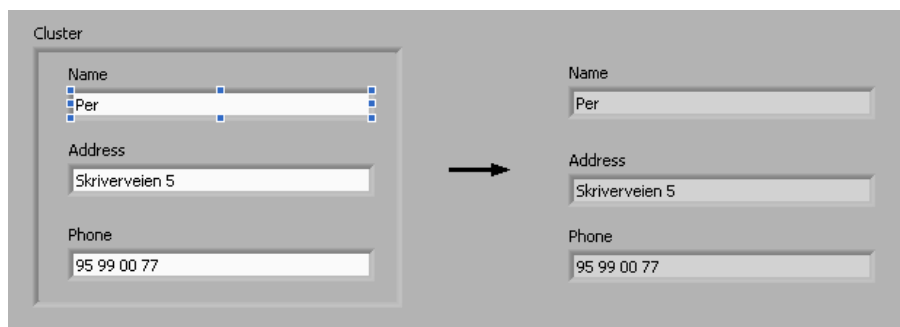

8 Working with Strings

Working and manipulating with strings is an important part in LabVIEW development.

On the Front panel we have the following String controls and indicators available from the Control palette:

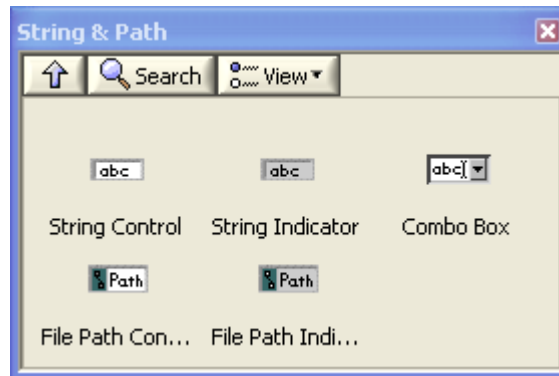

On the Block Diagram we have the following String functions available from the Functions palette:

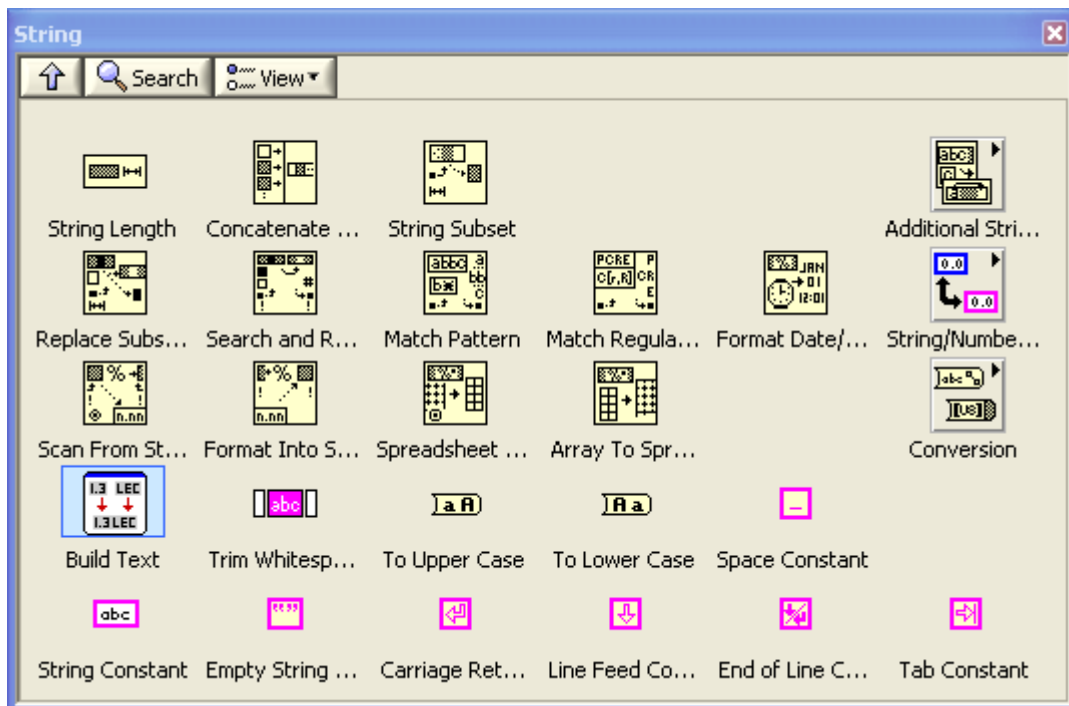

Some of the most important String functions are:

Concatenate Strings

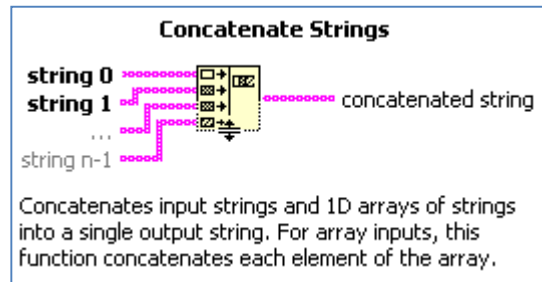

This function concatenates several strings into on string:

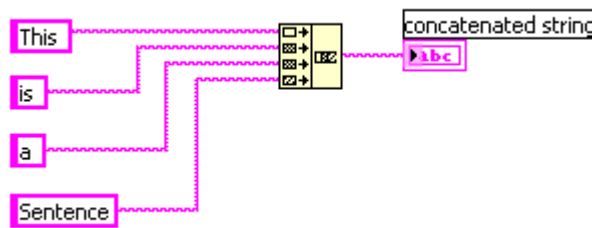

Search and Replace String

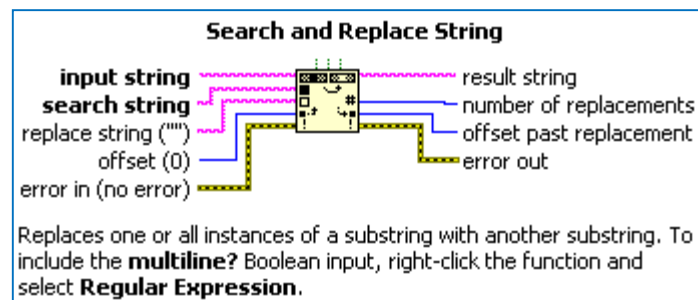

Use this when you want to replace or remove a certain text in a string.

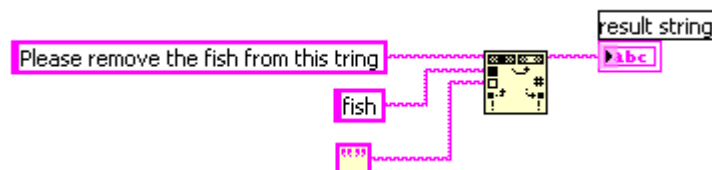

Match Pattern

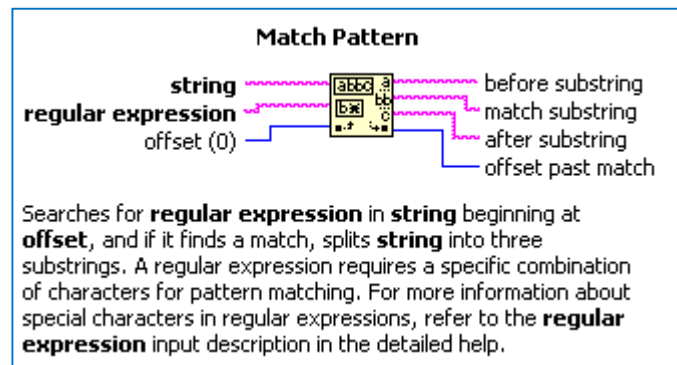

This is the most useful function when it comes to string manipulation.

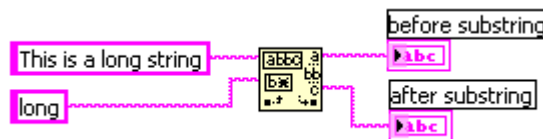

Format Into String

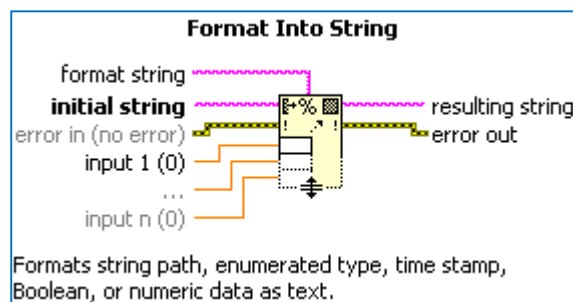

Example:

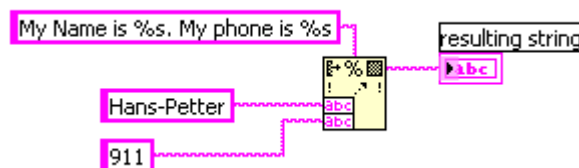

Exercises

Here are some exercises using some of the String functions that are available in LabVIEW.

Exercise: SubVI: Remove leading zeros in string.vi

Create a SubVI which removes leading zeros in a string. Create a Test VI that uses the SubVI.

Exercise: SubVI: Remove space from end of string.vi

Create a SubVI which removes all spaces from the end of the string. Create a Test VI that uses the SubVI.

Exercise: SubVI: Add 2 String.vi

Create a SubVI which adds 2 strings into one. Create a Test VI that uses the SubVI.

9 Error Handling

This chapter explains the basic concepts of handle errors in your code.

Topics:

- Finding Errors
- Error Wiring
- Error Handling

9.1 Finding Error

 If a VI does not run, it is a broken, or “nonexecutable”, VI. The Run button often appears broken, shown at left, when you create or edit a VI. If it is still broken when you finish wiring the block diagram, the VI is broken and will not run. Generally, this means that a required input is not wired, or a wire is broken. Click the broken Run button to display the Error list window, which lists all the errors. Double-click an error description to display the relevant block diagram or front panel and highlight the object that contains the error.

9.2 Error Wiring

Error handling is important in all programming languages. LabVIEW has powerful mechanism for handling errors and error wiring.

You should always wire the Error cluster between all SubVIs, nodes, etc. that support this, see example below.



The Error cluster is located in the Controls palette here:

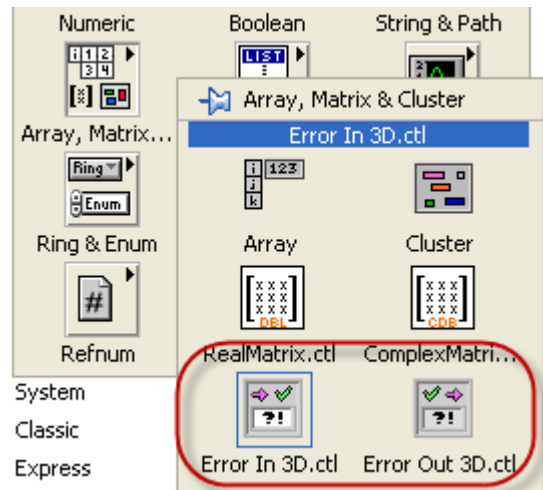

The Error Cluster:

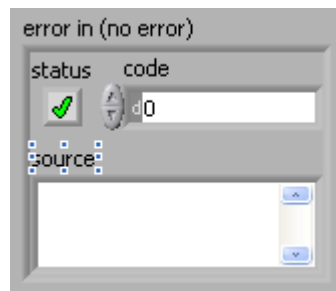

The Error cluster contains of the following parts:

- Status – True/False. False: No Error, True: Error
- Code – Error Code
- Source – Textual Error message

9.3 Error Handling in SubVIs

When creating SubVIs you should always create an Error In and an Error Out. In the SubVI code you should also use a Case structure and wire the Error in cluster to the Case Selector as shown below.

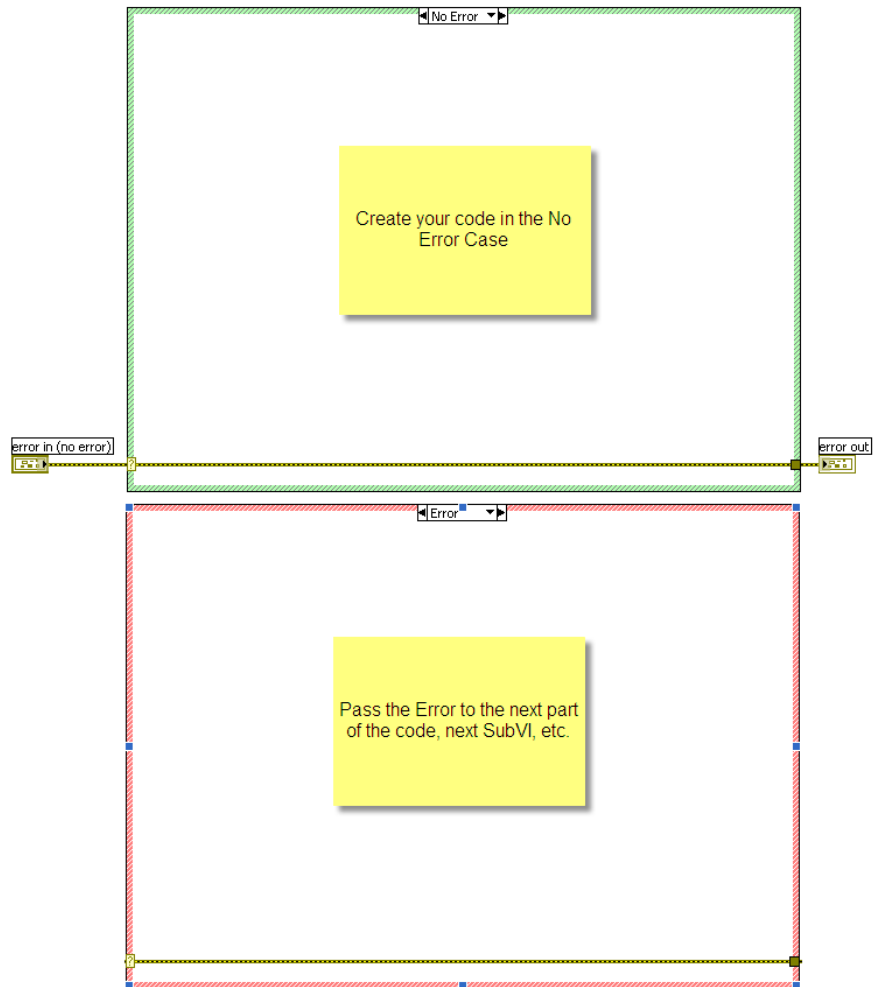

9.4 Error Handling

LabVIEW has several useful SubVIs, etc. for Error Handling:

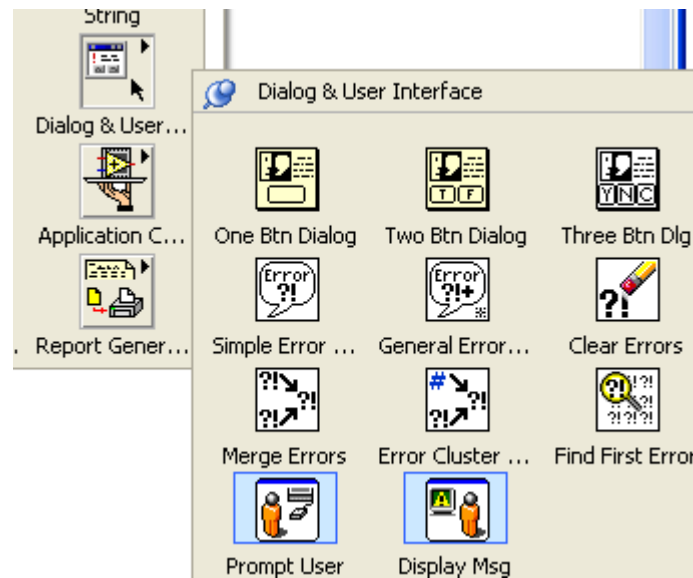

These are:

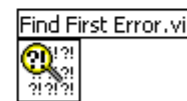
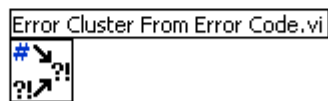
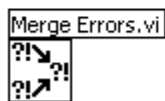
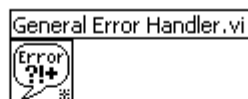
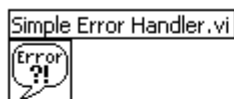

In general you should always show the error to the user. See LabVIEW Help for more details of how to use these SubVIs.

Exercises

Exercise: Error Handling

Check out the different Error Vis in LabVIEW. Use them in some of your previous Vis.

10 Working with Projects

This chapter explains the basic concepts of the project Explorer in LabVIEW.

Topics:

- Project Explorer
- Building .exe (executable) applications
- Deployment: Create an Installer

10.1 Project Explorer

It is not necessary to use the Project Explorer when developing your LabVIEW code, but it is an easy way to structure your code, especially for larger projects.

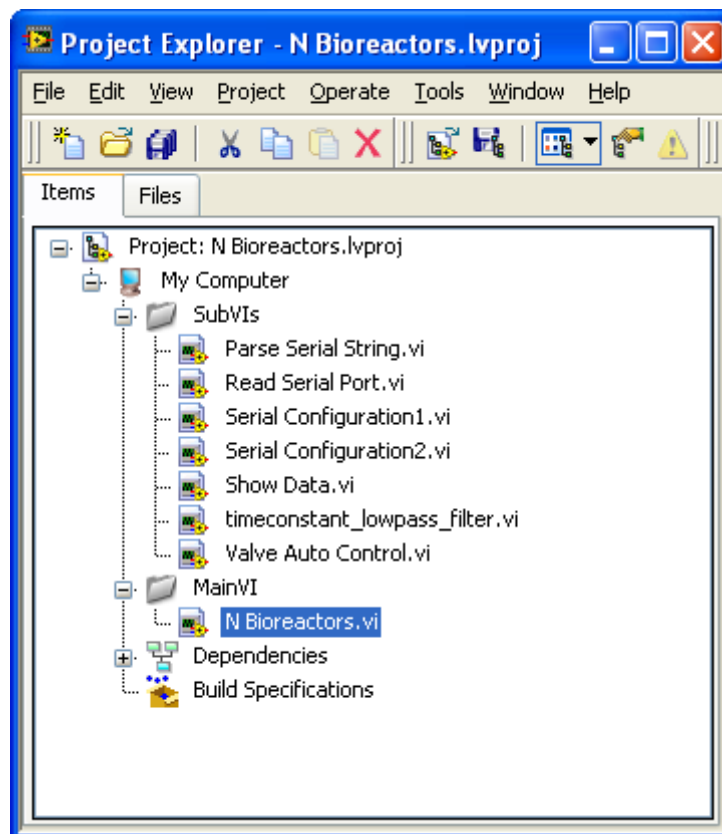

The project Explorer is necessary when you want to deploy your code into, e.g., an executable (.exe) application, build a setup, etc.

The Project Explorer is also very useful when you integrate a source control tool, such as Team Foundation Server, Visual Source Safe, etc. Then you may easily check files in and out of the source code system.

In order to create a new Project in LabVIEW, simply select “Empty Project” from the Getting Started window when you open LabVIEW.

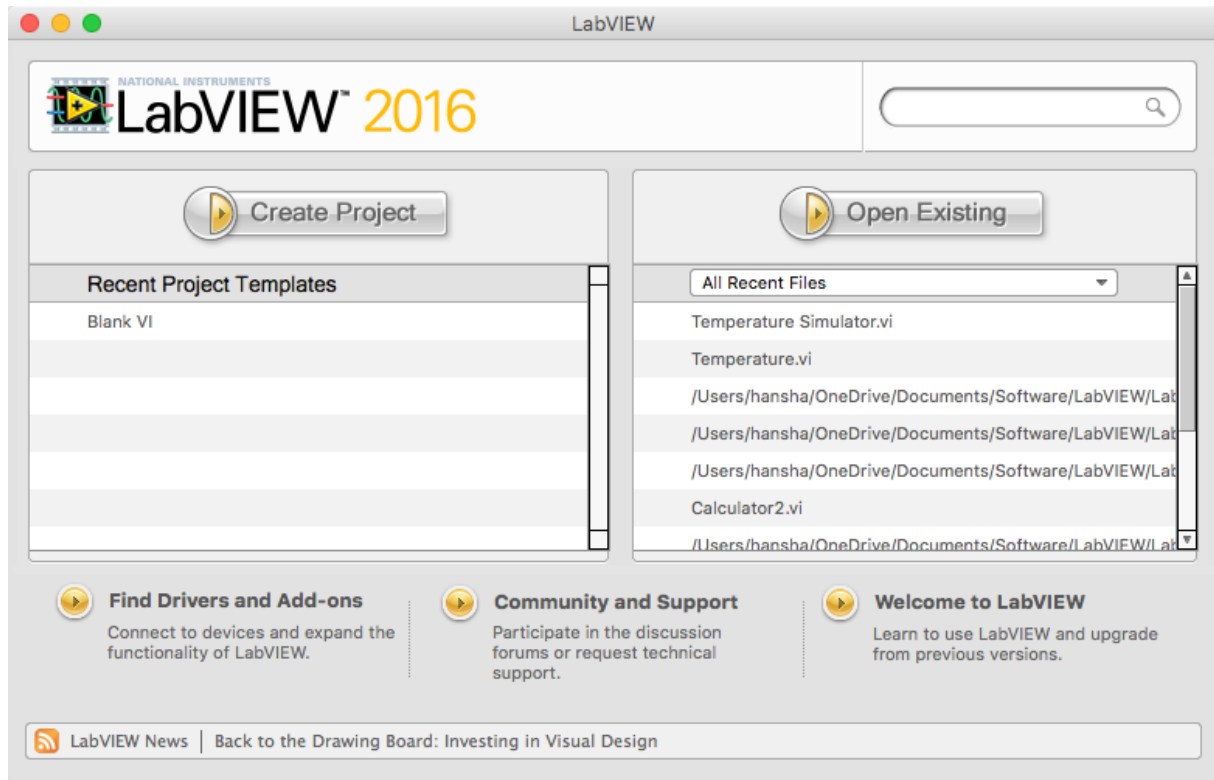

10.2 Deployment

When your application is finished, you may want to distribute or deploy your application and share it with others.

The Project Explorer gives you several choices when it comes to distribute and deploy your application. Some of the options are:

- Create an **executable** application (.exe) – this means that the target doesn’t need to have LabVIEW installed on their computer. All the target need is LabVIEW Run-Rime, which is a small installation package.
- You may create your own **installer**, so all the target need is to run a setup.exe in order to use your application
- Other possibilities is to create a **Web Service** or a Shared Library (**DLL**) of your application

All these options are available from the Project Explorer, just right-click on your “Build Specifications” node.

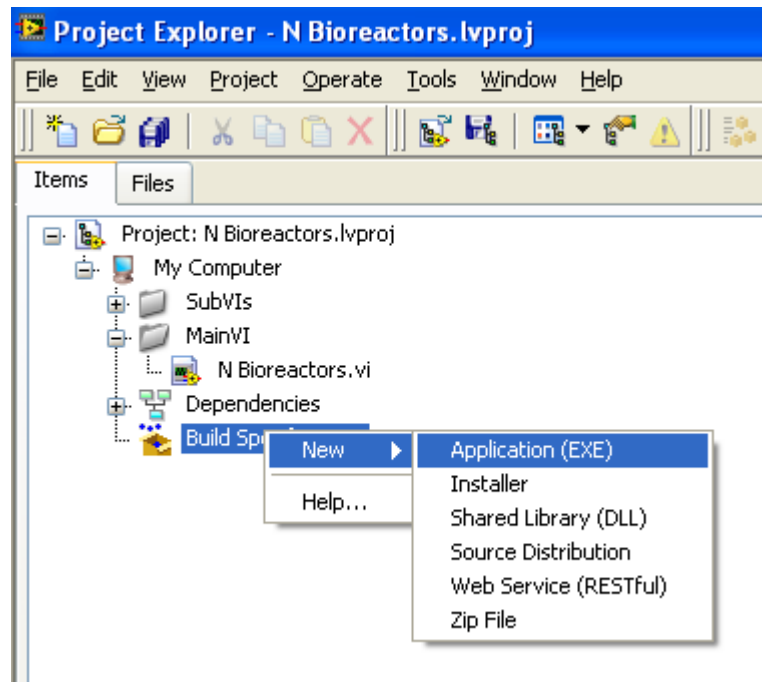

We will go through how we create an executable application. Click Build Specifications→New→Application (EXE).

In the Properties window fill in your name of the application.

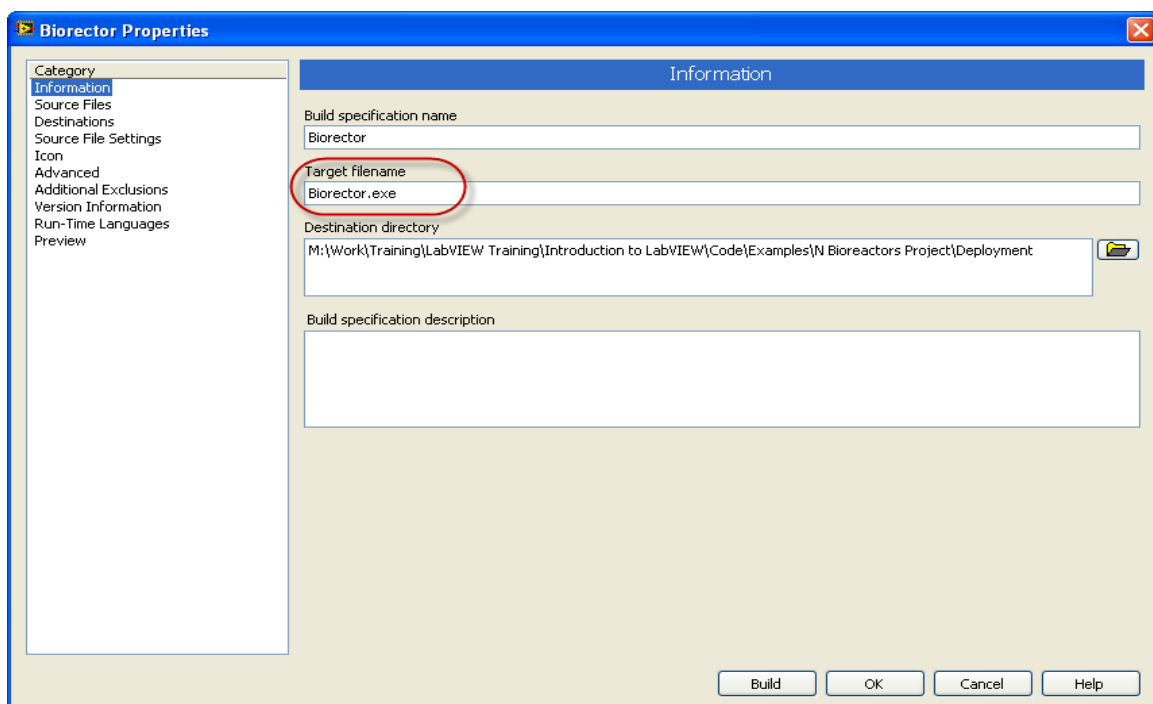

Make sure you select a Startup VI.

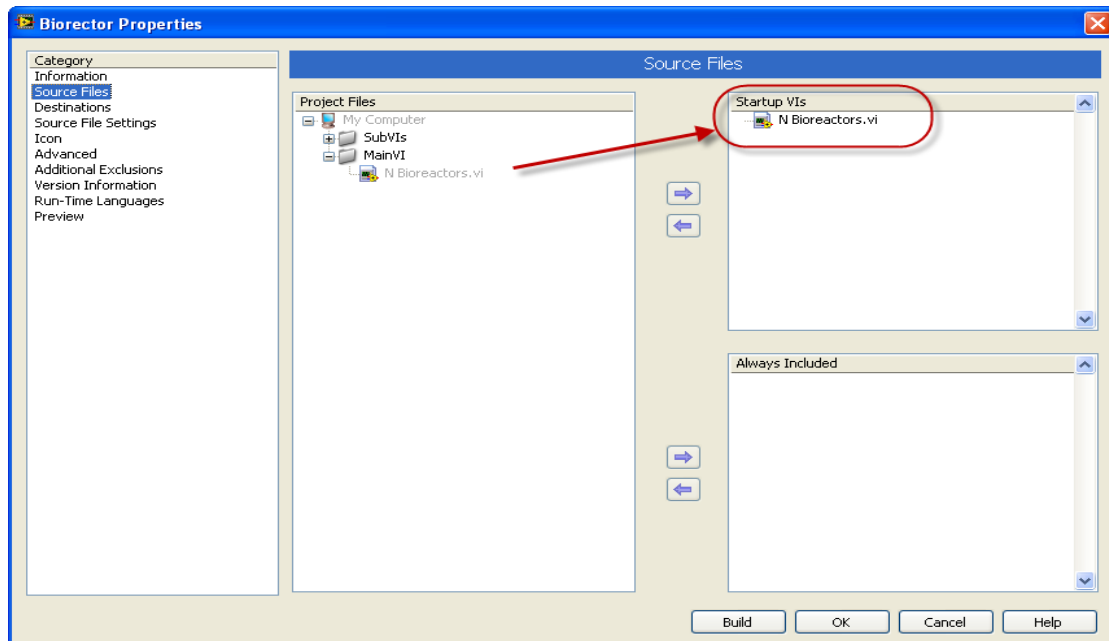

There are lots of properties and setting you may use in order to create your application, go through all the Categories in the Properties window.

When you have finished all the steps, just select “Build” in order to create your application.

When you make changes in your application, it is easy to rebuild your application:

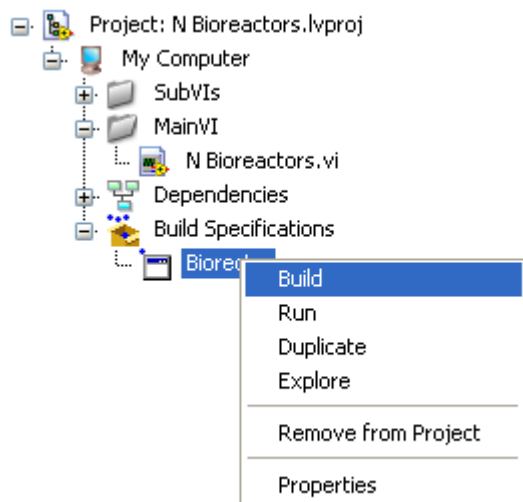

Exercises

Exercise: Project Explorer

Create a new Project and put on of your existing application into the project

Exercise: Deployment

Create an executable application

11 Design Techniques

This chapter explains some useful techniques to use when creating your application.

Topics:

- Force the Program Flow using an Error cluster
- Shift Register
- State Machine
- Multiple Loops
- Templates

11.1 Force Program Flow

As mentioned earlier, LabVIEW follows a dataflow model for running VIs. A block diagram node executes when all its inputs are available. When a node completes execution, it supplies data to its output terminals and passes the output data to the next node in the dataflow path.

In the example below we cannot be sure that the DAQmx Write.vi executes before the DAQmx Stop Task.vi executes. LabVIEW will in this case randomly execute one of these first. If the Stop VI happens to execute first then the Write VI will failed because task has been stopped.

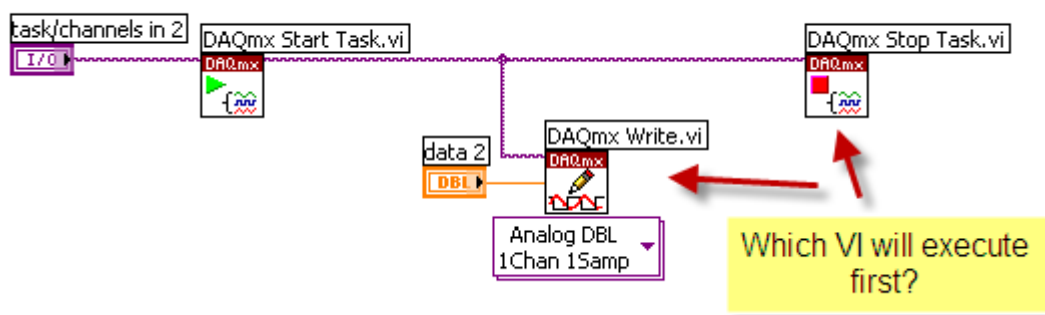

In the example below we wire the Error cluster through all the VIs, and there will be no doubt that the Write VI will execute before the Stop VI.

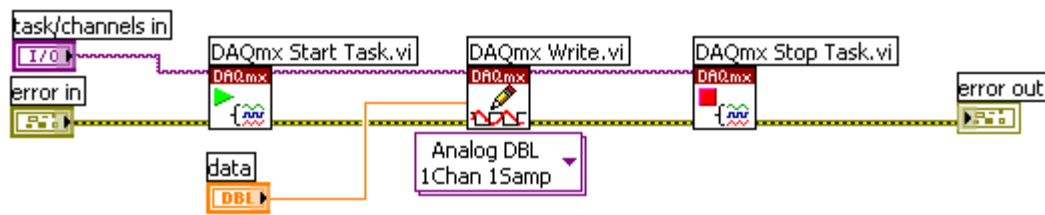

This approach will also take care of the error handling in your program, which is very important in real-world applications.

11.2 Shift Register

Use shift registers on For Loops and While Loops to transfer values from one loop iteration to the next. Shift registers are similar to static variables in text-based programming languages. A shift register appears as a pair of terminals, directly opposite each other on the vertical sides of the loop border. The right terminal contains an up arrow and stores data on the completion of an iteration. LabVIEW transfers the data connected to the right side of the register to the next iteration. Create a shift register by right-clicking the left or right border of a loop and selecting Add Shift Register from the shortcut menu.

A shift register transfers any data type and automatically changes to the data type of the first object wired to the shift register. The data you wire to the terminals of each shift register must be the same type.

To initialize a shift register, wire any value from outside the loop to the left terminal. If you do not initialize the shift register, the loop uses the value written to the shift register when the loop last executed or the default value for the data type if the loop has never executed.

Use a loop with an uninitialized shift register to run a VI repeatedly so that each time the VI runs, the initial output of the shift register is the last value from the previous execution. Use an uninitialized shift register to preserve state information between subsequent executions of a VI. After the loop executes, the last value stored in the shift register remains at the right terminal. If you wire the right terminal outside the loop, the wire transfers the last value stored in the shift register. You can add more than one shift register to a loop. If you have multiple operations within a loop, use multiple shift registers to store the data values from those different processes in the structure.

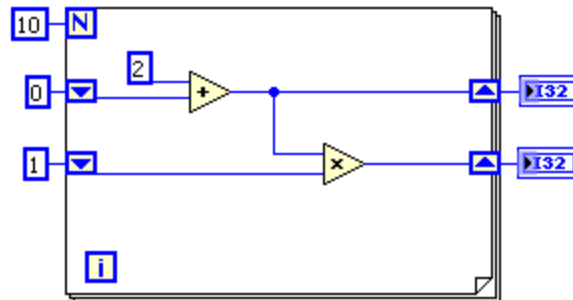

11.3 State Programming Architecture

Creating VIs using the State Machine approach is very useful when creating (large) applications.

In general, a state machine is a model of behavior composed of a finite number of states, transitions between those states, and actions. It is similar to a "flow graph" where we can inspect the way in which the logic runs when certain conditions are met.

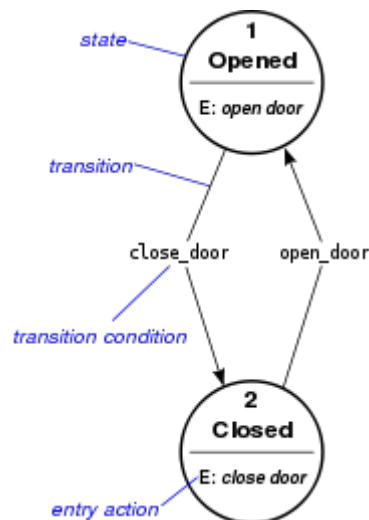

Sometimes, you may want to change the order of the sequence, repeat one item in the sequence more often than the other items, stop a sequence immediately, or have items in the sequence that may execute only when certain conditions are met. Although your program may not have any such requirements, there is always the possibility that the program must be modified in the future. Therefore, a state programming architecture is a good choice, even if a sequential programming structure is sufficient. The following list describes more complex programming requirements that justify the use of a state programming architecture for an application.

- You need to change the order of the sequence
- You must repeat an item in the sequence more often than other items
- You want some items in the sequence to execute only when certain conditions are met

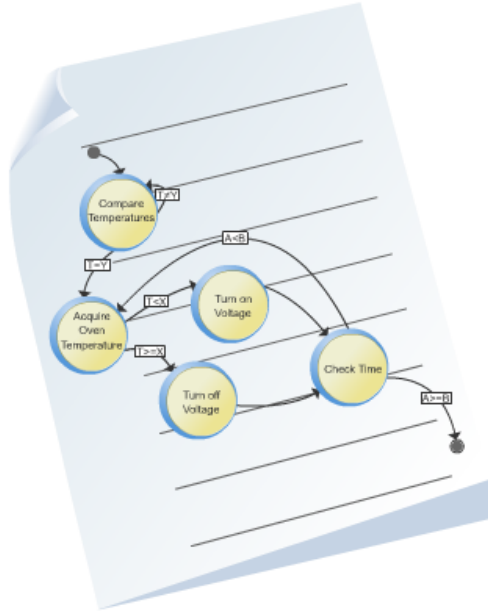

The State Machine approach in LabVIEW uses a Case structure inside a While loop to handle the different states in the program, and the transitions between them. The Shift Register is used to save data from and between the different states.

Below we see examples of a state machine principle implemented in LabVIEW.

Simple State Machine principle

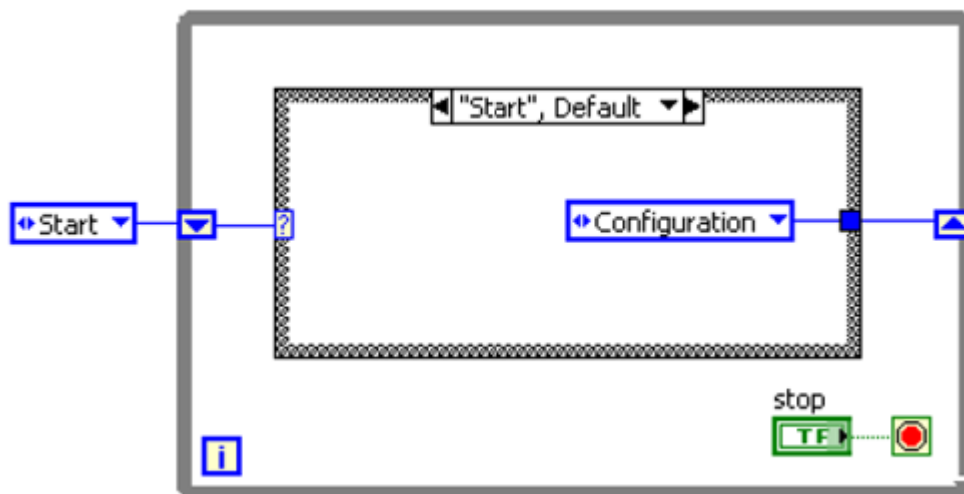

State Machine with multiple transitions depending on the State:

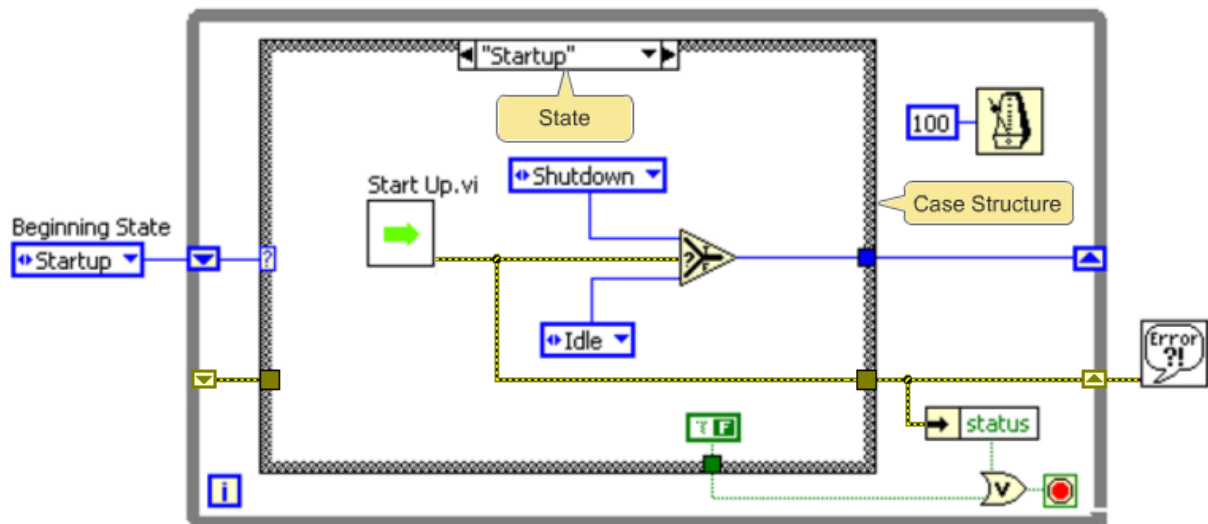

More advanced State Machine using Shift Registers:

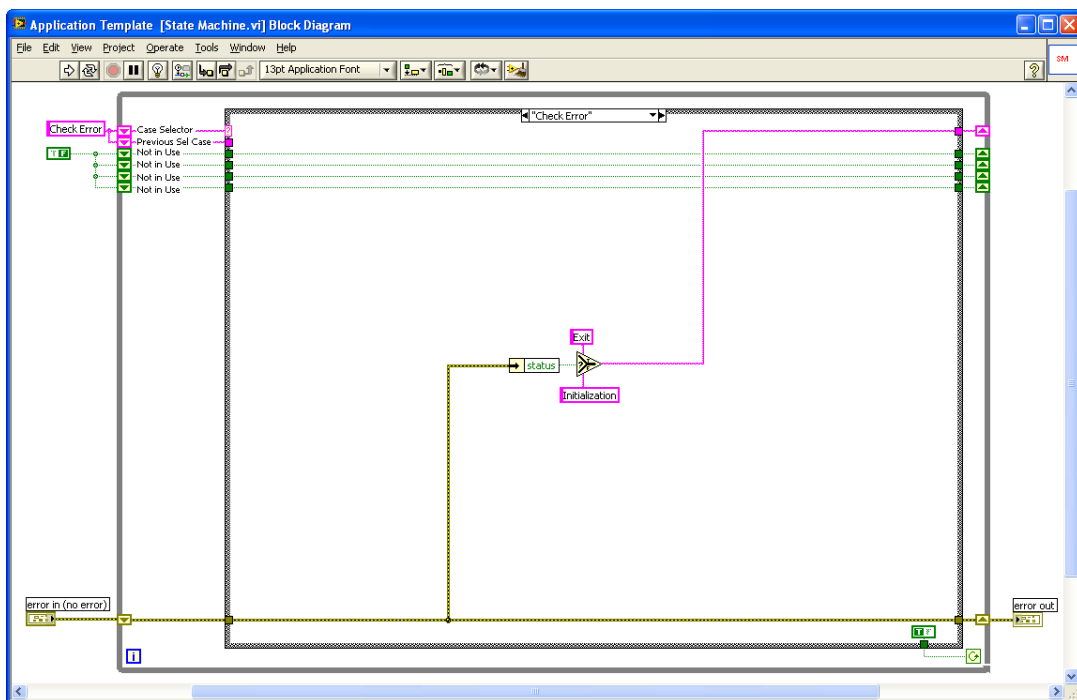

11.4 Multiple Loops/Parallel programming

Often, you need to program multiple tasks so that they execute at the same time. In LabVIEW tasks can run in parallel if they do not have a data dependency between them, and

if they are not using the same shared resource. An example of a shared resource is a file, or an instrument.

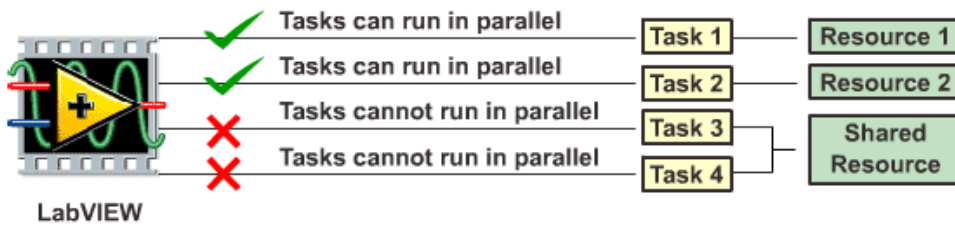

Using multiple While loops is sometimes useful in applications that need to handle User interactions in parallel with, e.g., DAQ operations, etc.

Below we see an example of how this structure could look like. The upper loop could handle interaction with the user, while the lower loop could handle DAQ operations, such as reading and writing to some I/O equipment.

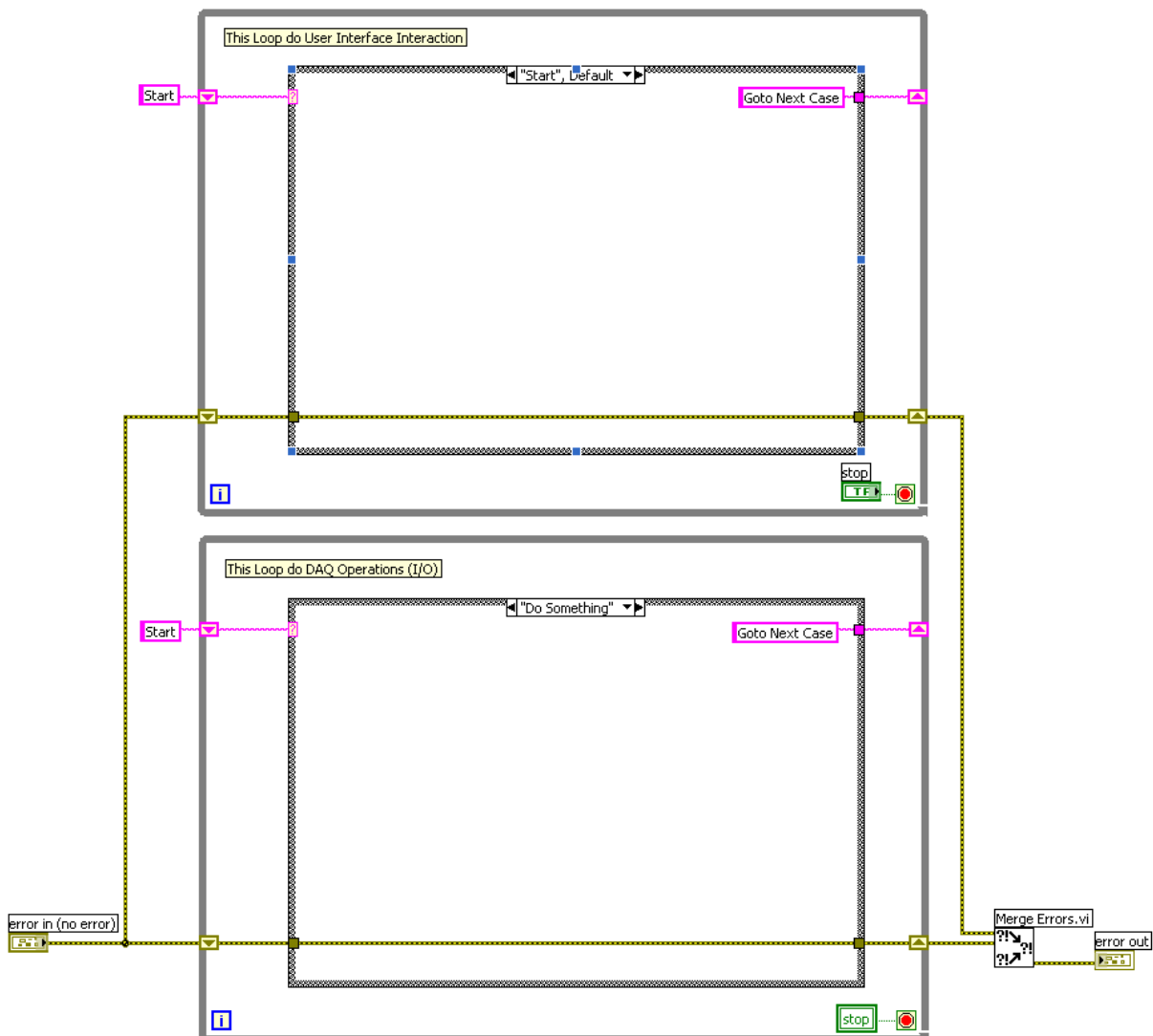

In order to pass data between the loops, you may e.g. use local variables. The loop may have different time cycles. The I/O may require faster cycles than the User interaction loop.

11.5 Templates

You should create your own templates for such VI you use a lot. It is easy to create your own templates for scratch, just create a VI as you normally do and then save it as a template with the ending “.vit”. You may also convert a VI you already made just by changing the extension to “.vit”.

You should copy your templates to the LabVIEW template folder which is default located in “C:\Program Files\National Instruments\LabVIEW X.X\Templates\”.

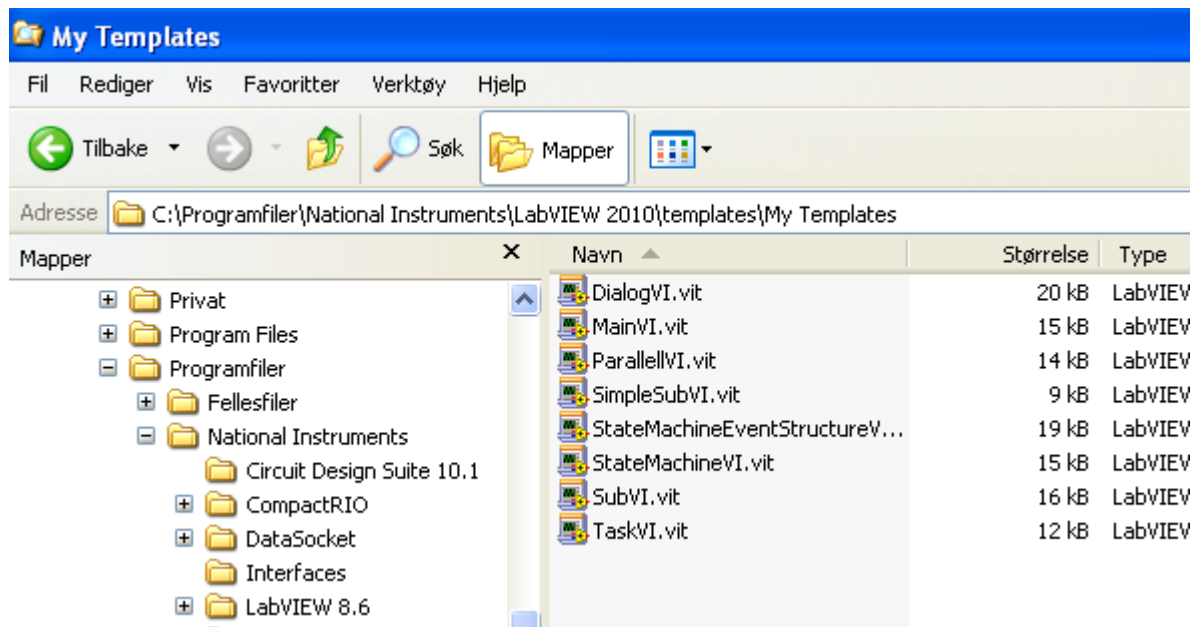

The Templates will then be available from the Getting Started Window or File→New... in LabVIEW.

In my case I have created a sub folder called “My Templates” where I place all my templates.

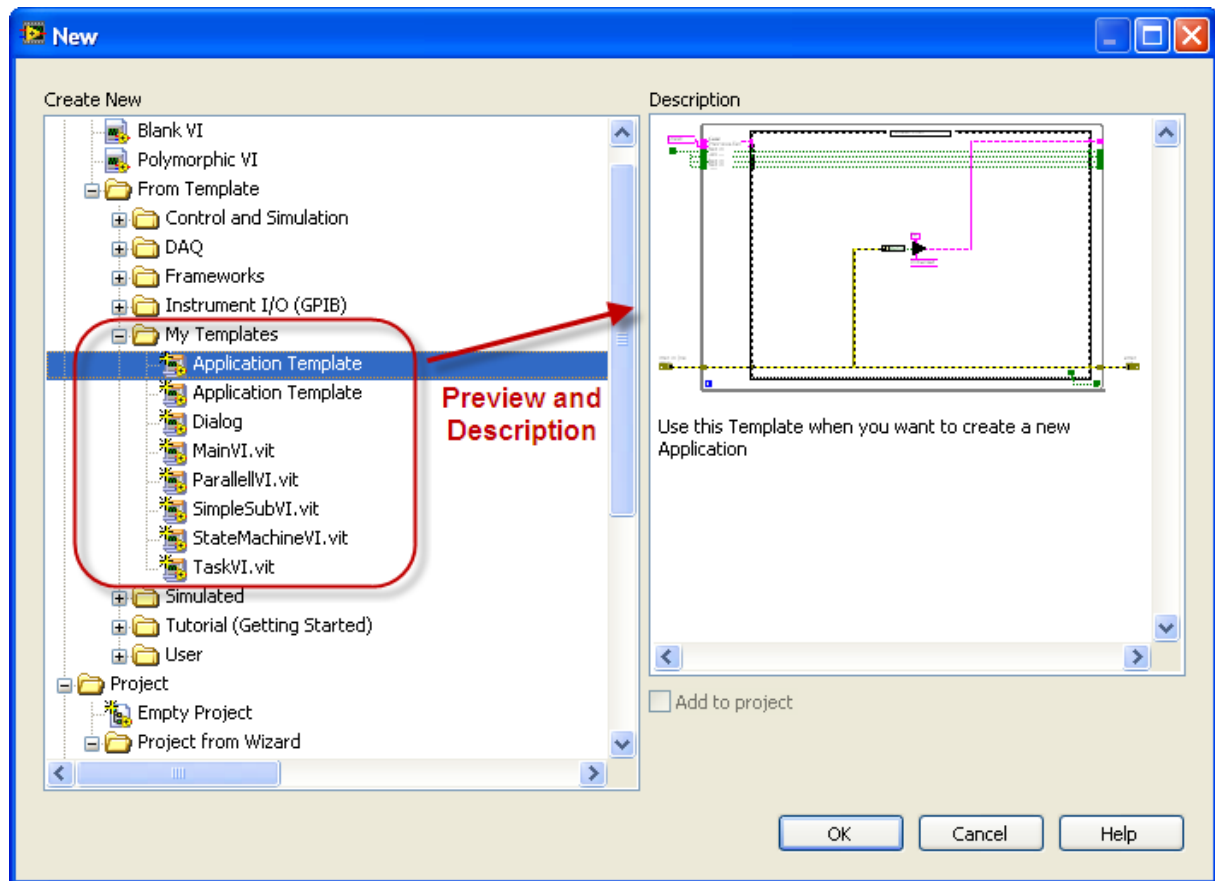

Exercises

Here are some exercises about shift-registers, State Machines and parallel programming.

Exercise: Shift-register

Create a VI (see example below) where you have the following states:

- Initialize
- Write
- Read
- Close

In the VI you will use a shift-register as a temporary storage. In the Write state you Write Data to the storage (shift-register) while you in the Read state will read the Data from the Storage.

See Example below:

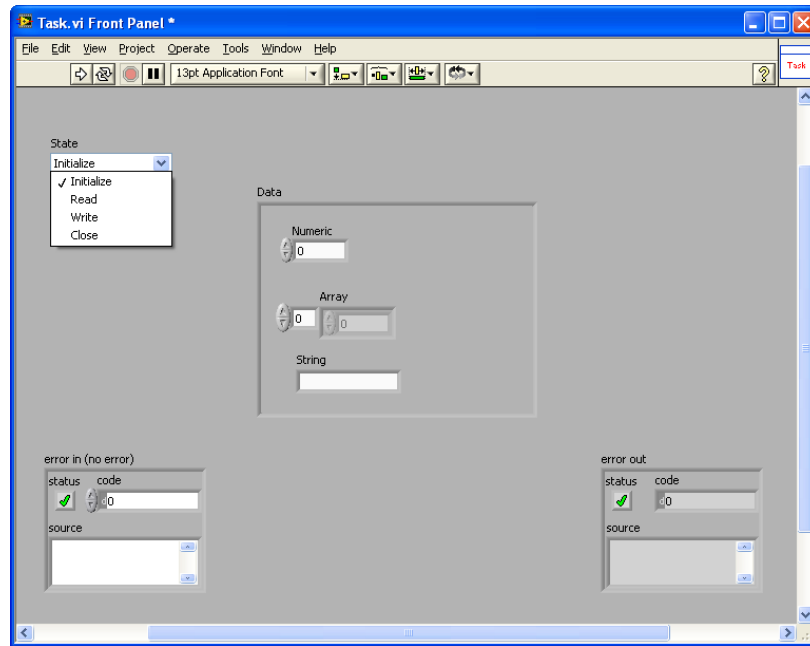

Write a Test program that test the SubVI, e.g.,

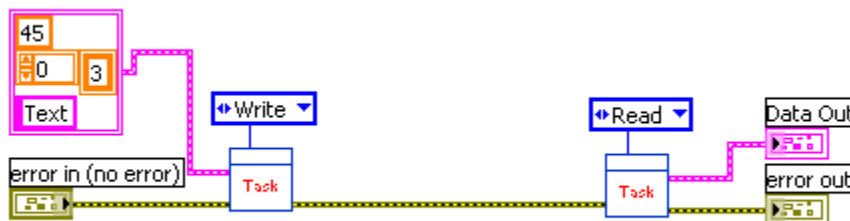

This example shows how you can use a shift-register as a temporary storage, which is very useful in many situations.

Exercise: State Machine

Use the State Machine principle on one of your previous exercises.

Exercise: Parallel Programming

Create a VI that consists of 2 parallel loops. Use local variables and other mechanisms in order to share data between the 2 loops.

Exercise: Templates

Strip some of your previous VIs and save them as reusable Templates.

12 User Interface

This chapter explains the basic concepts of creating user-friendly Graphical User Interfaces (GUI) in LabVIEW.

Topics:

- Decorations
- Tab Control
- Splitter
- Sub Panel
- Etc.

Below we see a Front Panel (GUI) with a “poor” design.

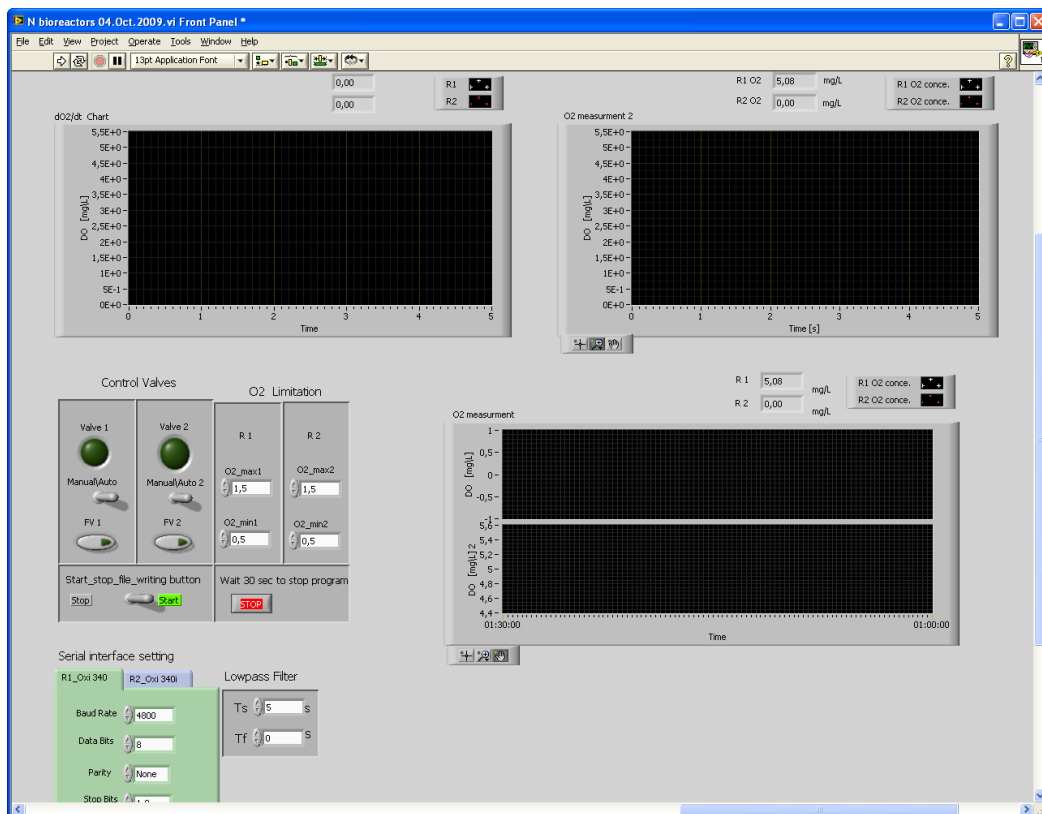

The information (Controls and Indicators) on the Front Panel is not structured. You should group elements that naturally belong together and use different colors with care.

When creating Graphical User Interfaces (GUI) you should use the controls from the System palette and not from the Modern or Classic palettes. Modern Controls may be used in Sub Vis with no visible User Interface (for the user).

The appearance of the controls in the System palette is standard MS Windows look and feeling and this look is familiar for most users. These controls also change appearance due to changes in the appearance in the operation system.

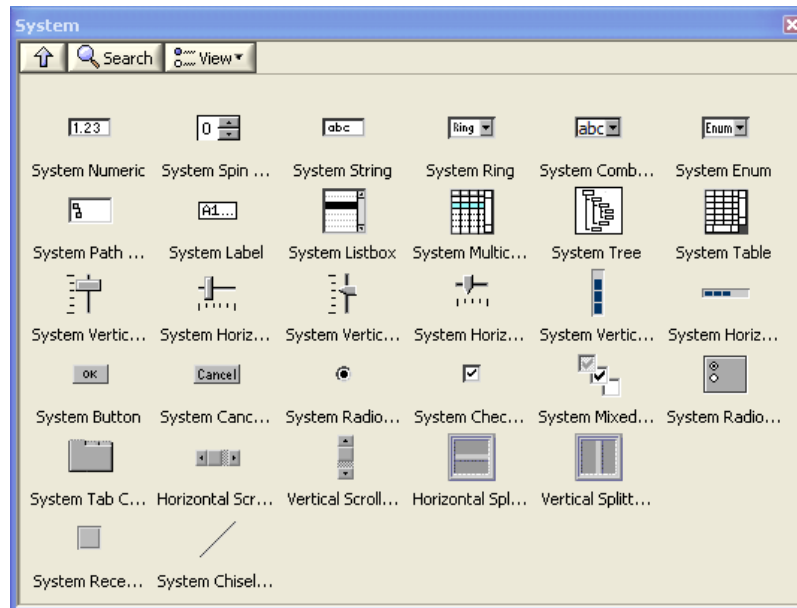

12.1 VI Properties

In order to make the appearance of the Window that hosts your application, you should always make some changes in the “VI Properties”.

You find the “VI Properties” by right-click on the icon in the upper right corner of your VI.

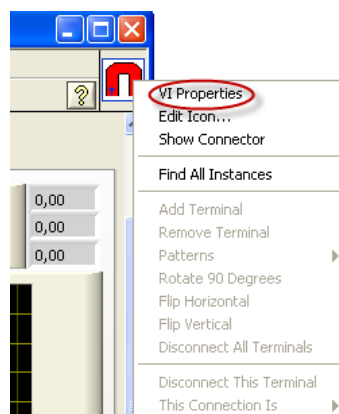

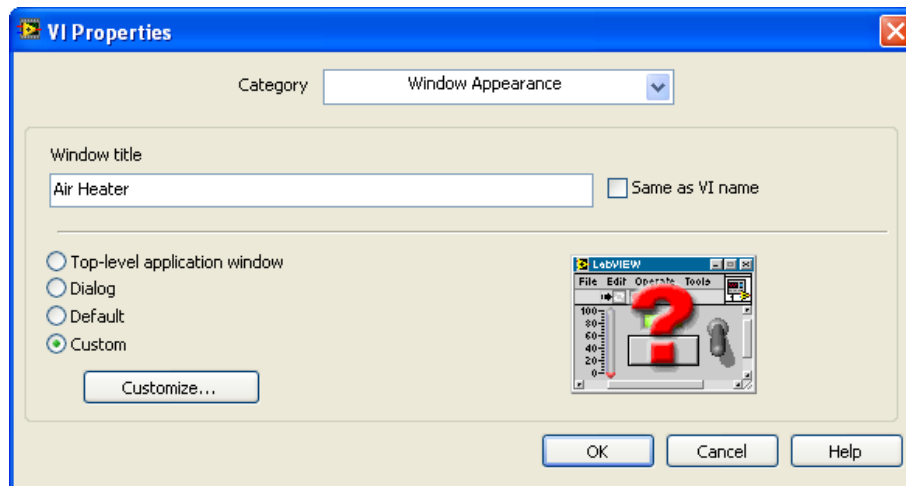

The first thing you should change is the “Window title”. Here you may type appropriate name of your application or SubVI.

The next you should do is to the “Customize” button in order to customize the Window appearance.

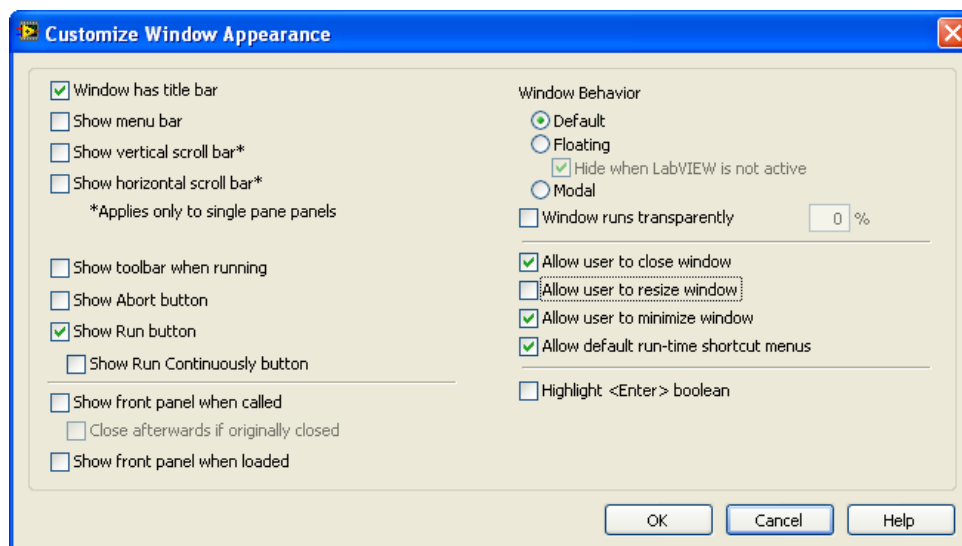

Below we see an application with a simple and neat User Interface and with a Customized Windows appearance.

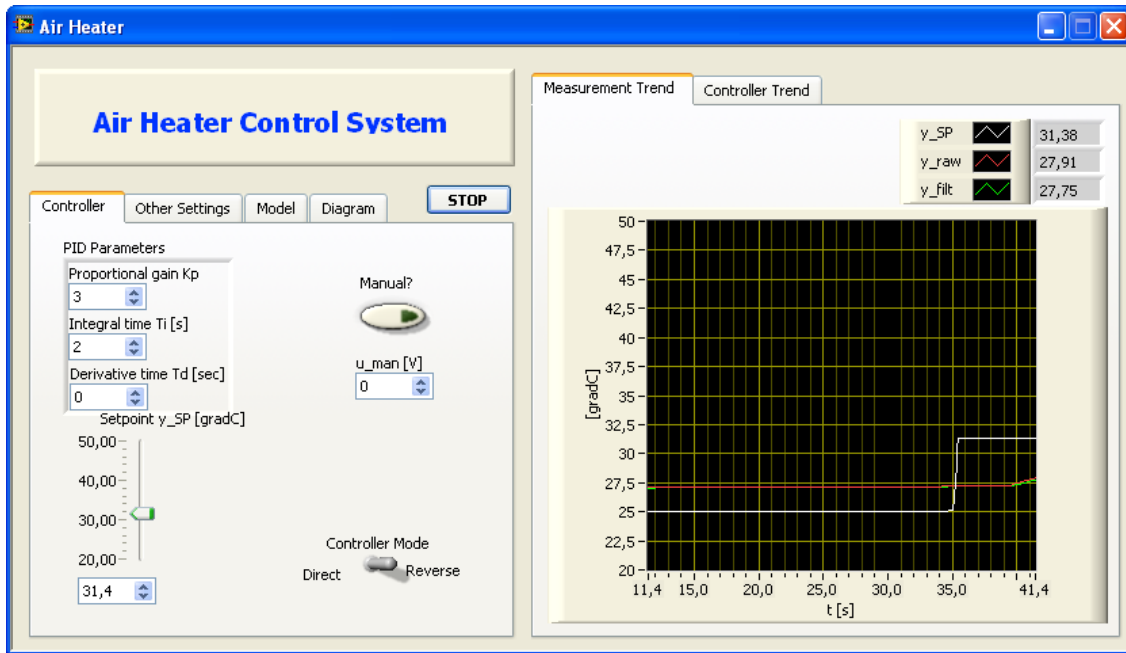

Below we see a professional application created in LabVIEW that implement common GUI objects such as a Toolbar, a Tree view, a List view, etc..

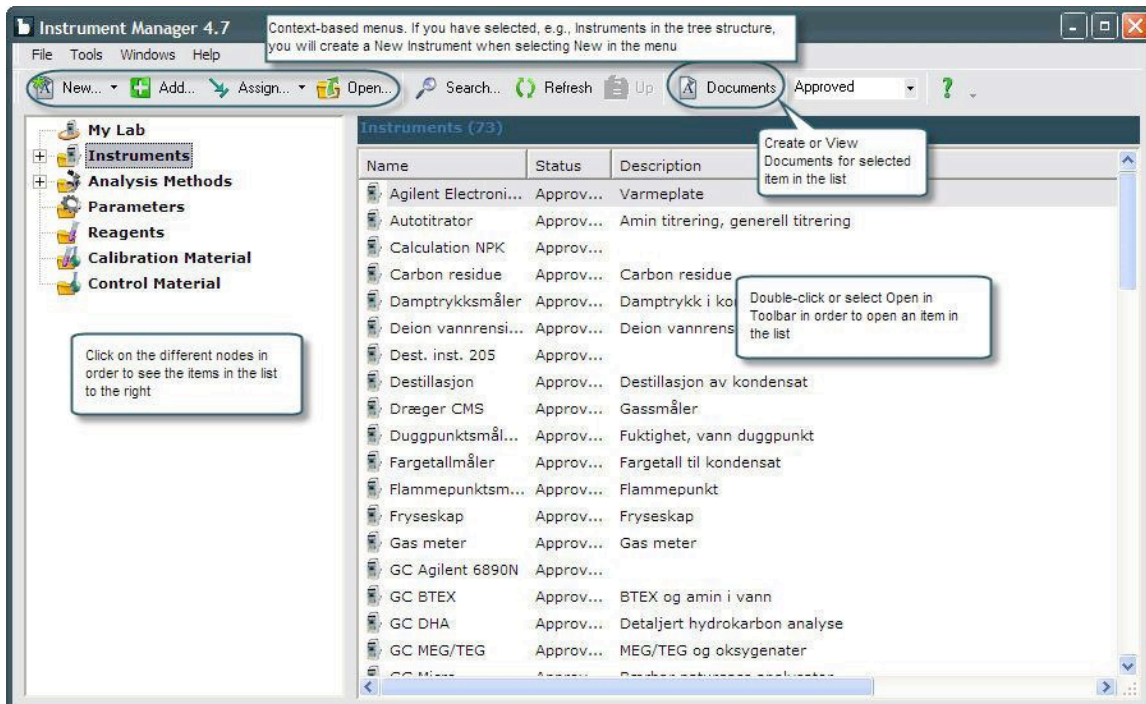

Exercises

Exercise: User Interface

Create a Dialog Box where you use some of the Controls from the System palette. Make the necessary settings in VI Properties in order to hide menus, buttons, create a Title, etc.

Create a Test VI from where you open this Dialog Box, enter some data in the Dialog Box, and then retrieve these data in the calling VI.

Example:

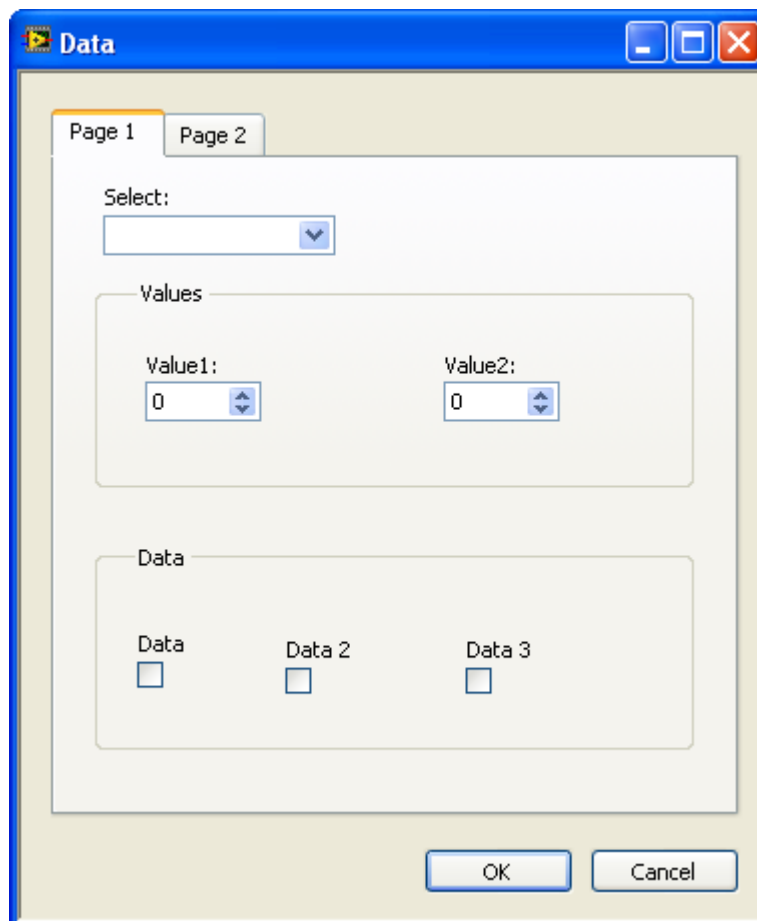

13 Plotting Data

This chapter explains the basic concepts when plotting data in LabVIEW.

LabVIEW offers powerful functionality for plotting data. In the Graph palette we have lots of useful controls for plotting and visualization of data.

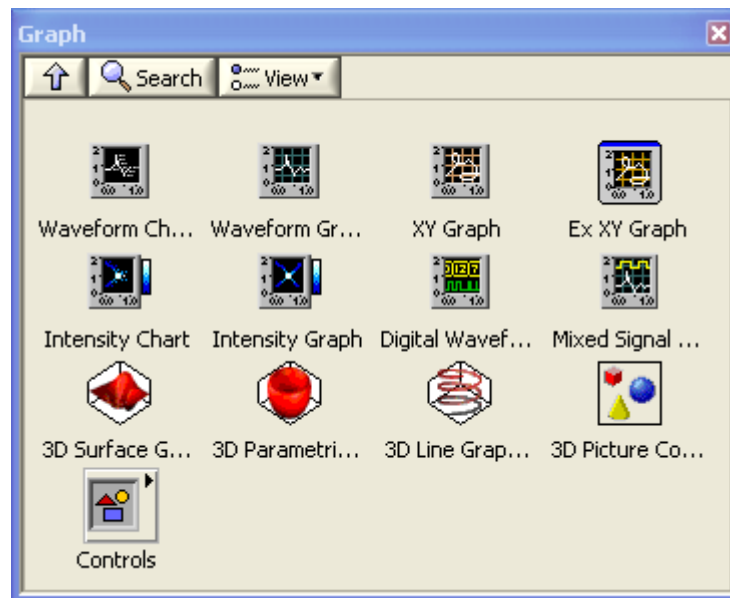

The most useful are:

- Waveform Chart
- Waveform Graph
- XY Graph

Example:

This simple example creates a graph with some random values.

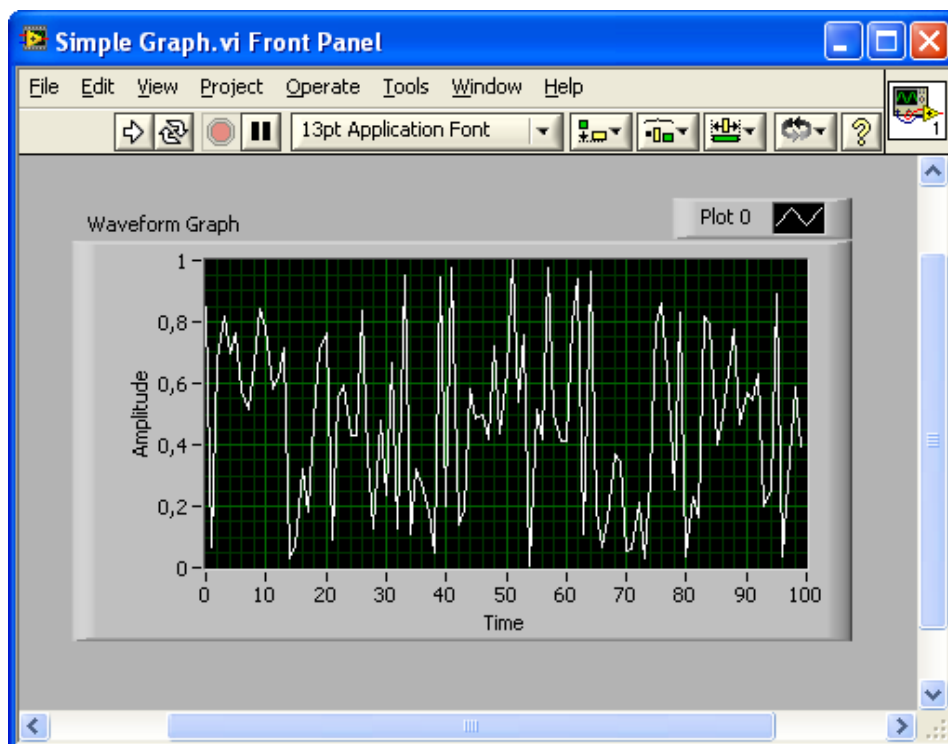
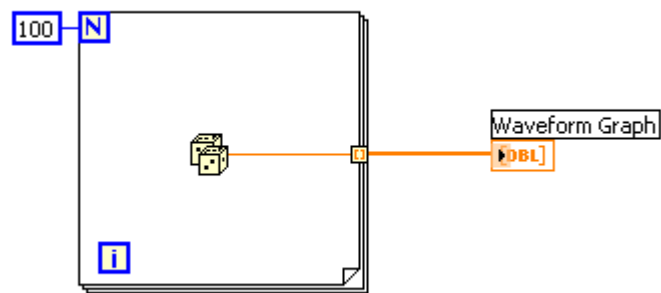

The example below show the basic difference between a “Chart” and a “Graph”.

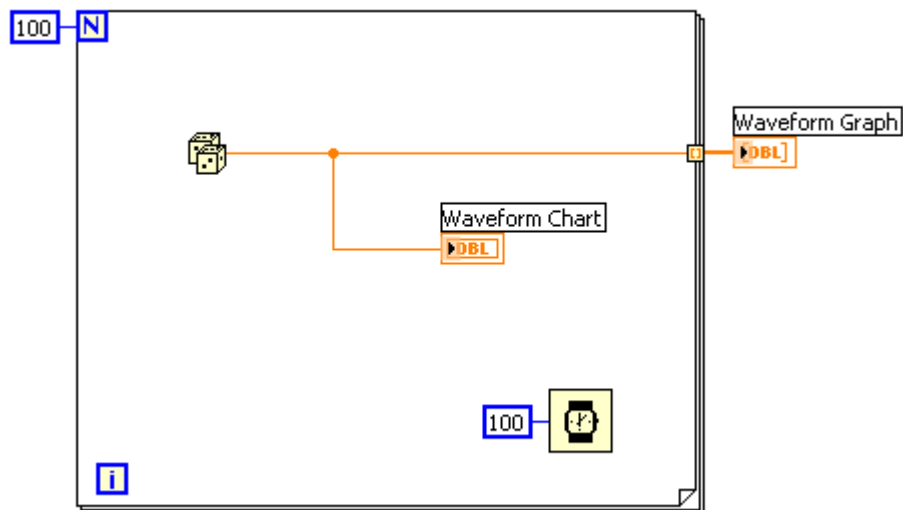

You use the “Graph” if you want to plot a set of data, e.g., an array with data, plot data from a file, etc. Use the “Chart” if you want to plot one data point at a time, e.g., inside a loop, etc.

13.1 Customizing

The different Chart components in LabVIEW offer a great deal of customizing.

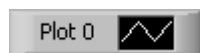

You may click on the “**Plot Legend**” in order to set colors, different line styles, etc.

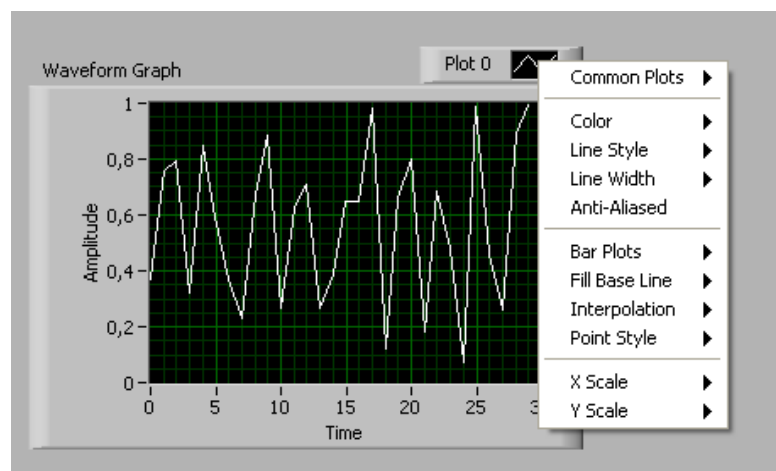

If you right-click on the Graph/Chart, you may set properties such as auto-scaling, etc.

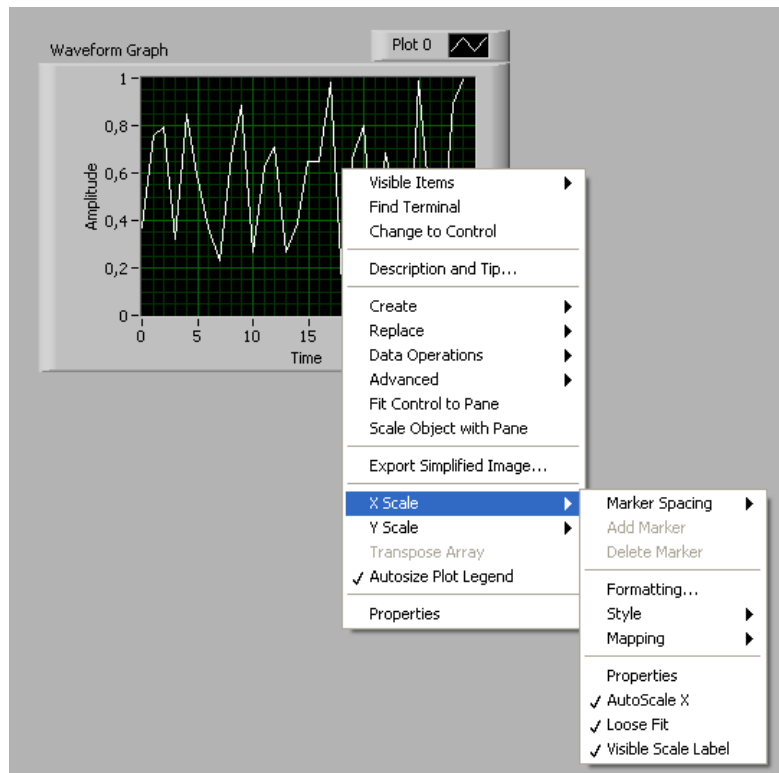

If you select Properties, you get the following dialog:

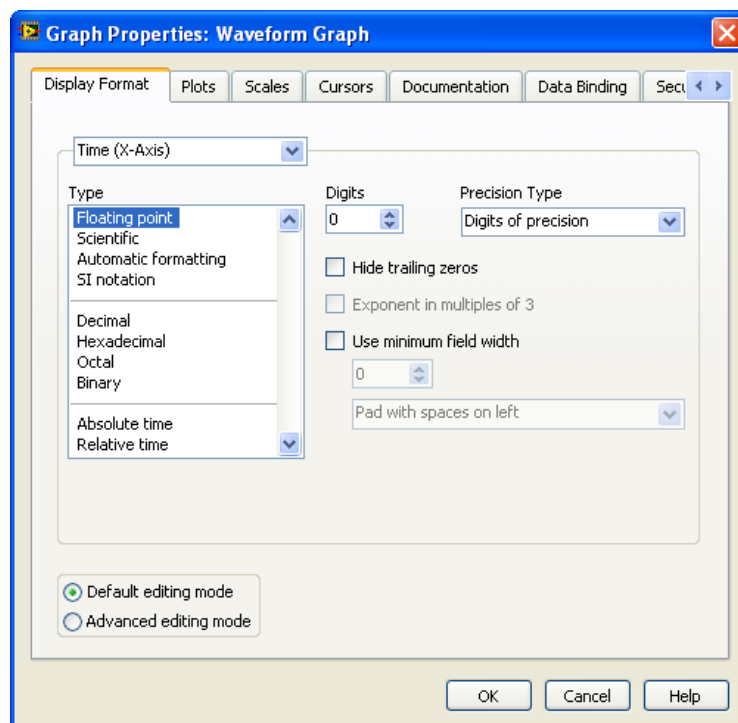

You may also select which items that should be visible or not.

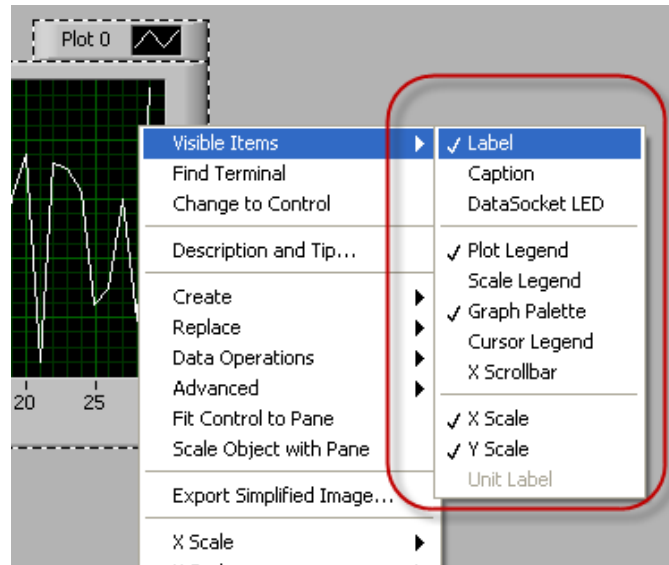

The “**Graph Palette**” lets you zoom in and out on the Graph, etc.

Exercises

Exercise: Graph

Create a VI that reads data from a file and plot the data in a Graph component.

Exercise: Chart

Create a VI where you use Data Binding in order to retrieve data from an OPC demo.

Data Binding is set in the Properties → Data Binding tab:

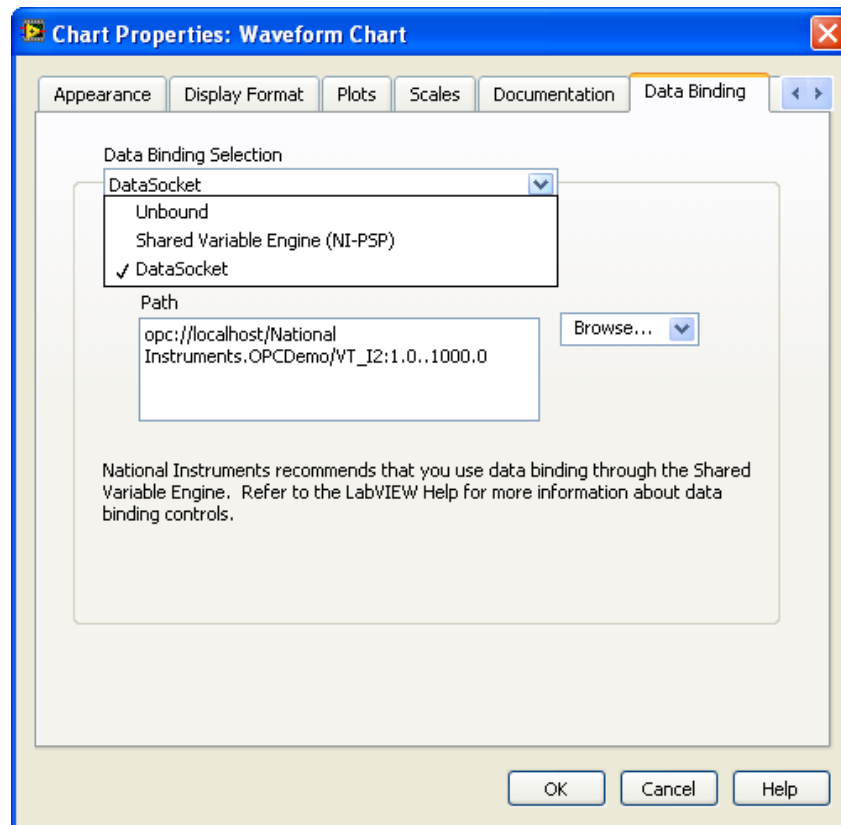

Exercise: Customizing

Customize the Graph and the Chart in the examples above in order to set colors, line thickness, etc.

14 Tips & Tricks

This chapter gives you some useful Tips & Tricks regarding LabVIEW.

14.1 10 functions you need to know about

These are the 10 most useful functions in LabVIEW, so you could already now learn how to use them and where to find them!

Build Array

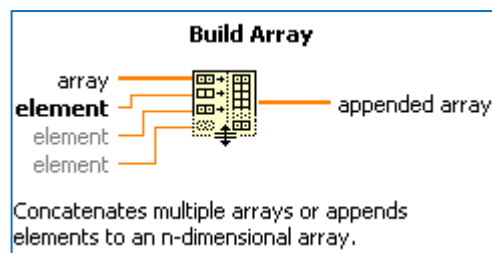

This example using the Build Array function inside a For loop in order build an array with 10 elements.

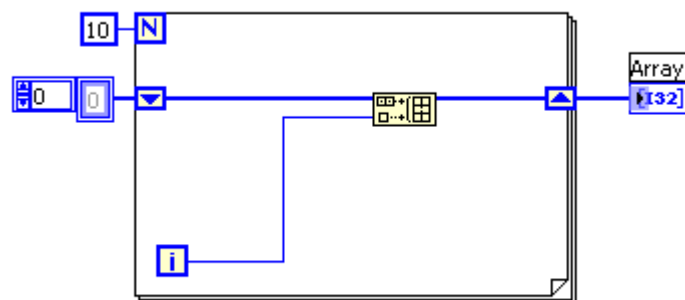

Index Array

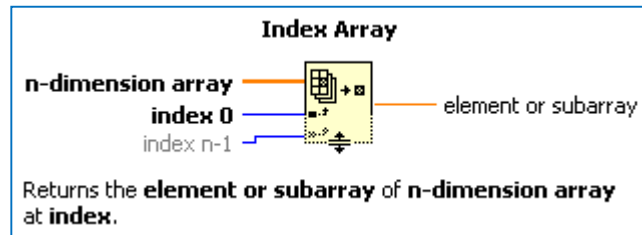

It is always useful to find a specific value in an array:

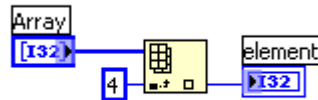

The Index Array is extendible, so you can drag it out to find more than one elements:

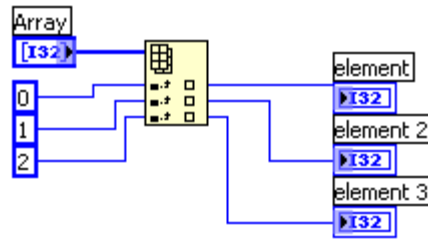

Array Size

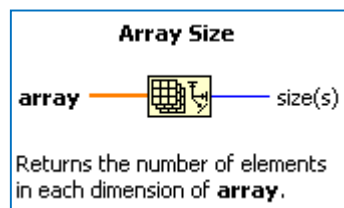

Find the size of an arbitrary array:

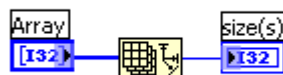

Select

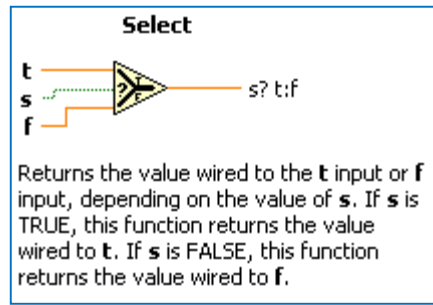

Depending on the input data, go to the Alarm case or the Write Data case.

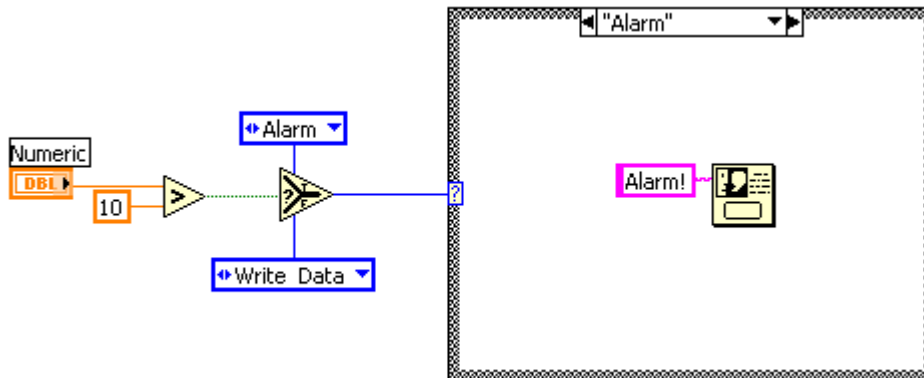

Concatenate Strings

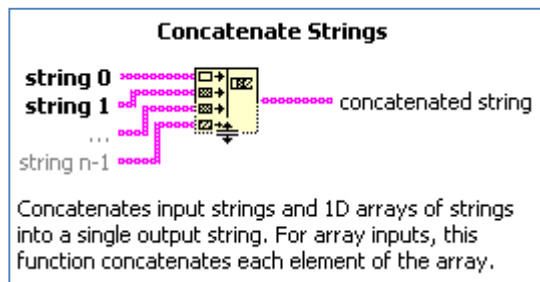

This function concatenate several strings into on string:

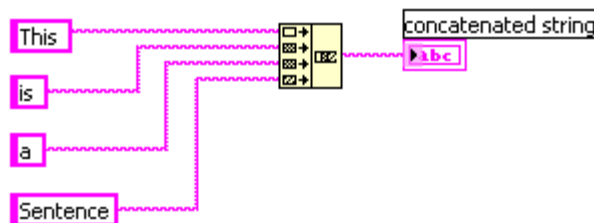

Search and Replace String

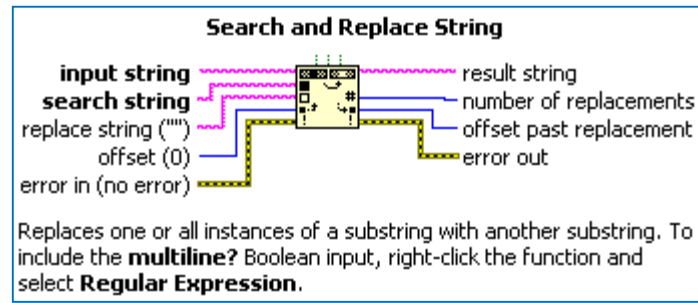

Use this when you want to replace or remove a certain text in a string.

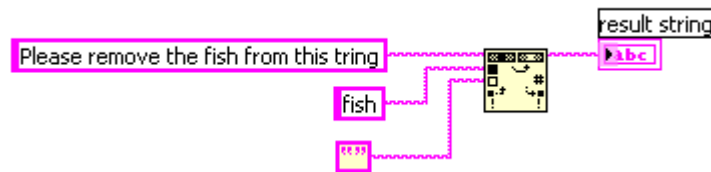

Match Pattern

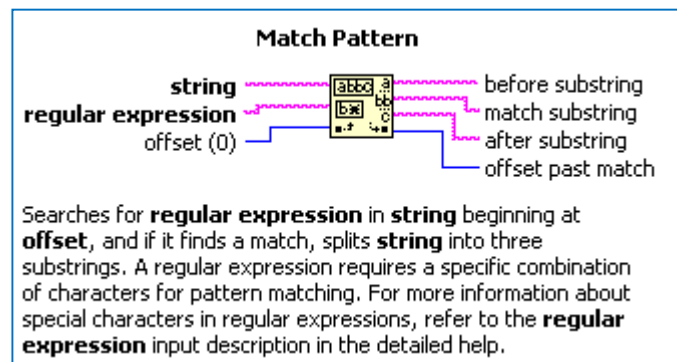

This is the most useful function when it comes to string manipulation.

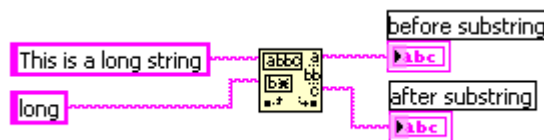

Format Into String

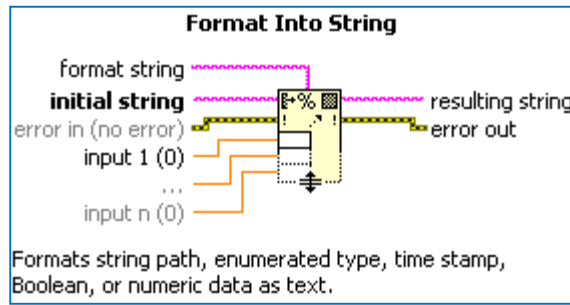

Example:

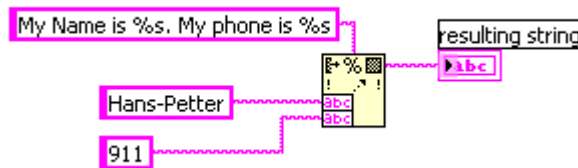

Fract/Exp String to Number

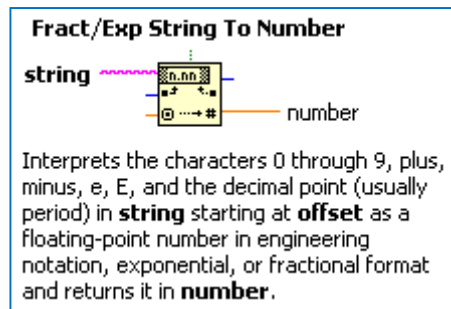

This function converts a string into a number:

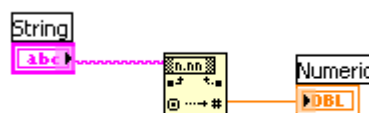

Example: Number To Fractional String

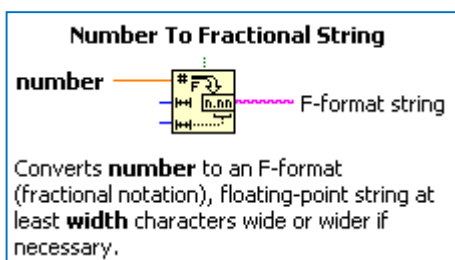

Example:

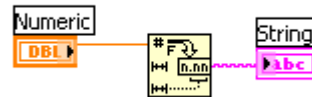

14.2 The 10 most useful Short-cuts

These are the 10 most useful short-cuts in LabVIEW, so you could already now learn how to use them!

Short-Cut	Description
Ctrl + B	Deletes all broken wires in a VI
Ctrl + .	Stops the Running VI
Ctrl + E	Toggle between the Front Panel and Block Diagram
Tab	Cycles through the most common Tools (Automatic Tool Selection should be disabled!)
Ctrl + Mouse wheel	Scrolls through subdiagrams in Case, Event or Sequence structures
Ctrl + H	Displays the Context Help window
Ctrl + Mouse Double-click on a SubVI	Opens the Block Diagram directly
Ctrl + Arrows (→←↶↷)	Move faster. You first have to select a SubVI, a Function, Object, etc
Ctrl + W	Close the SubVI
Double-click on a wire	Selects the hole wire

15 Example Application

In this example, we will go through an example application. The application uses most of the LabVIEW features you have learned in this Tutorial.

The application is called “Glossary”. It is a simple application that learns kid’s words in English. Since the application is for kids, the user interface is create with a “childish” look and feel.

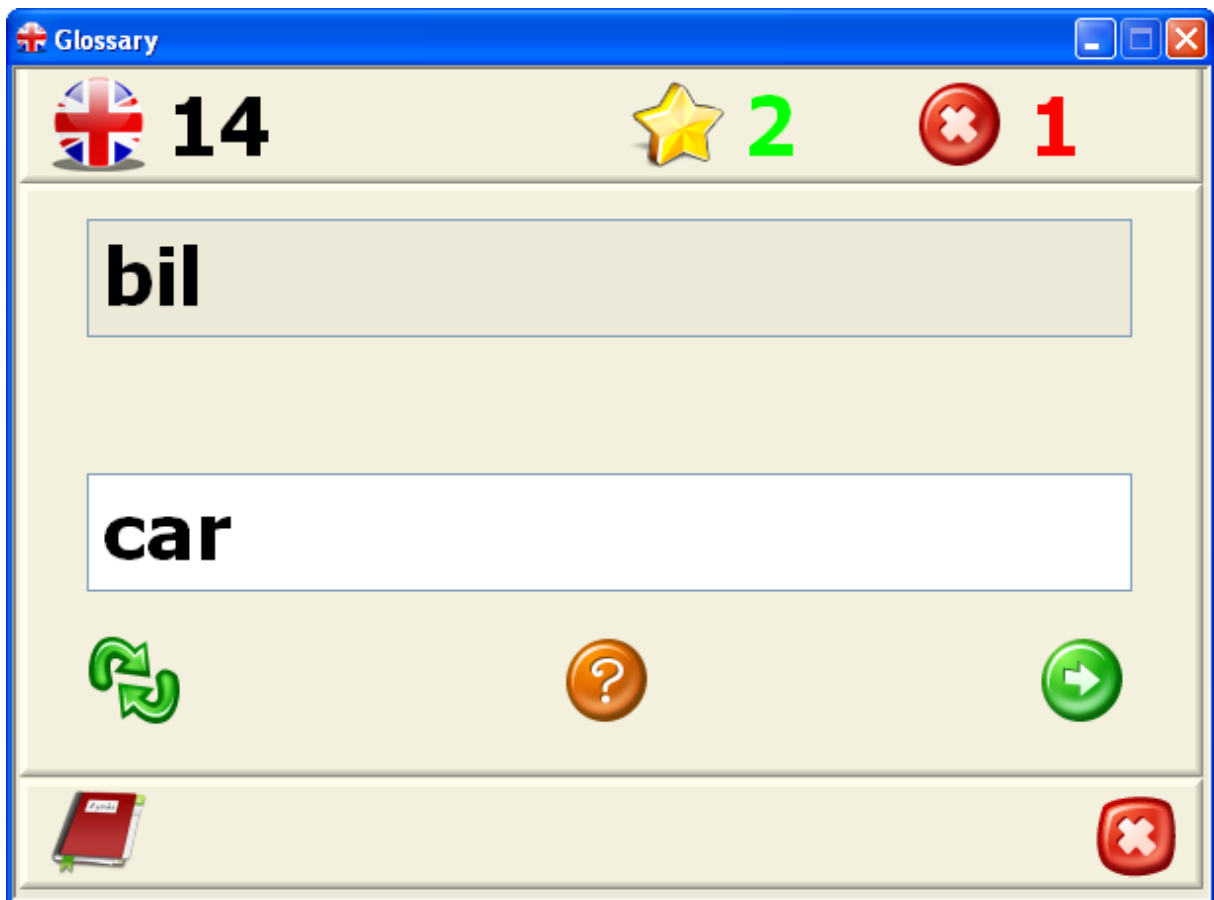

This is an example of how to create a user-friendly application in LabVIEW that uses most of the functionality in LabVIEW, such as State-machine principles, reading and writing to files, dialog boxes, graphics and sound effects. Basic functions for string and array manipulation, and of course while loops, case structures, subVIs, etc. The example also uses the Project Explorer to collect all the files in one place and to create an executable file of the solution. Finally it uses the Project Explorer to create a setup package you can use to install the application easily on other computers.

I created this application for my kids in the Primary school who had problems with learning their homework in English.

Below we see the Glossary List:



If you click on the little book symbol in your application, this window will pop up:

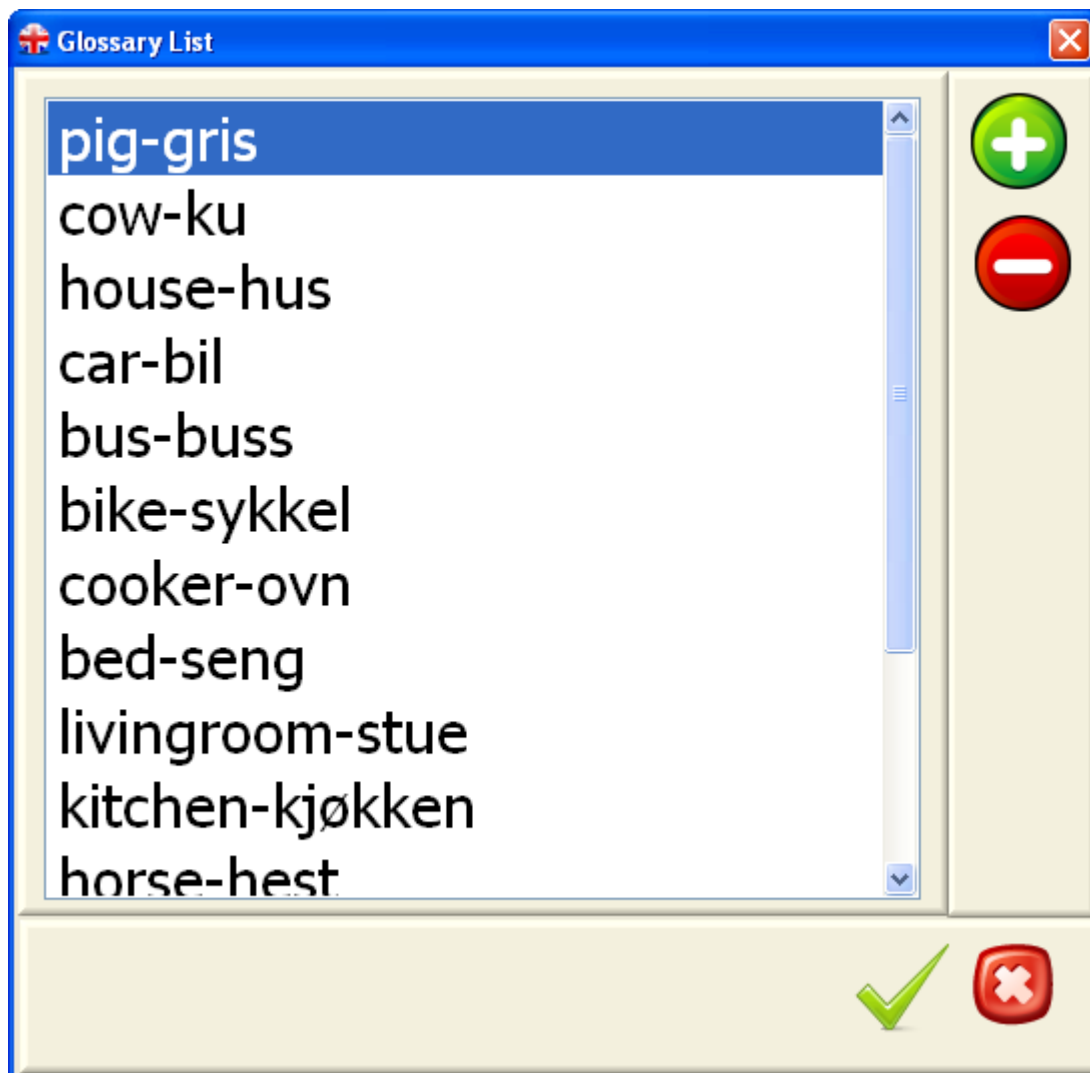

Click tis symbol and you can enter new words:

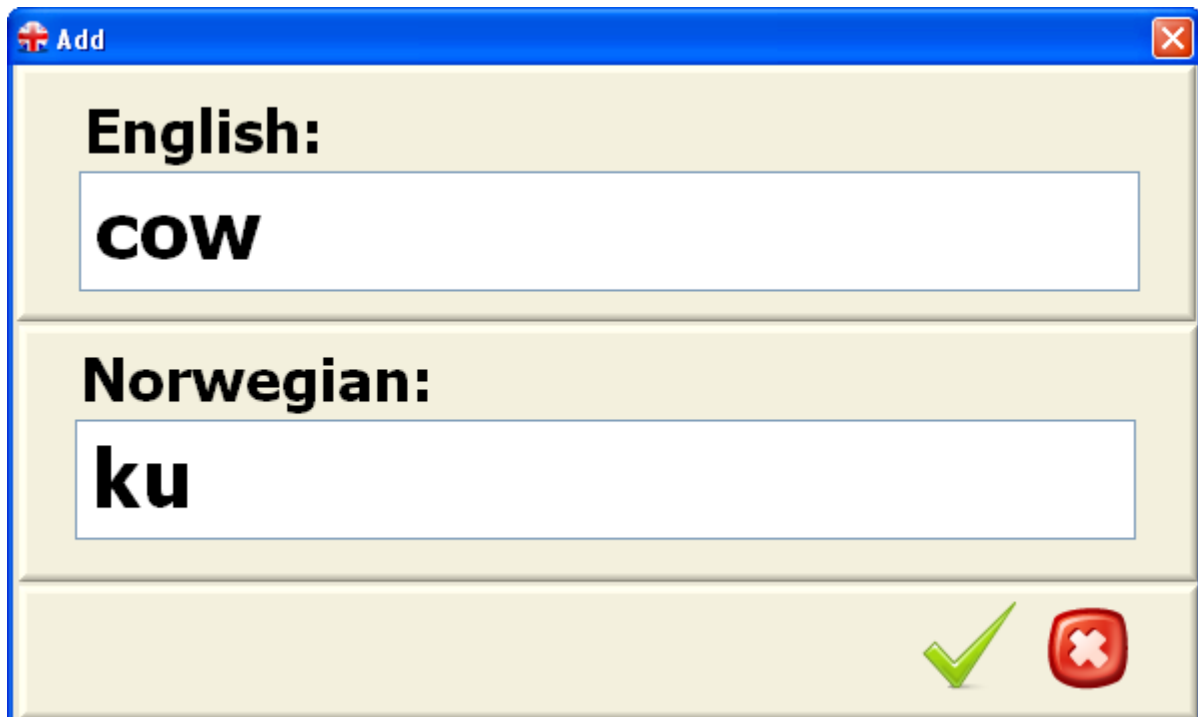

The application uses the Project Explorer:

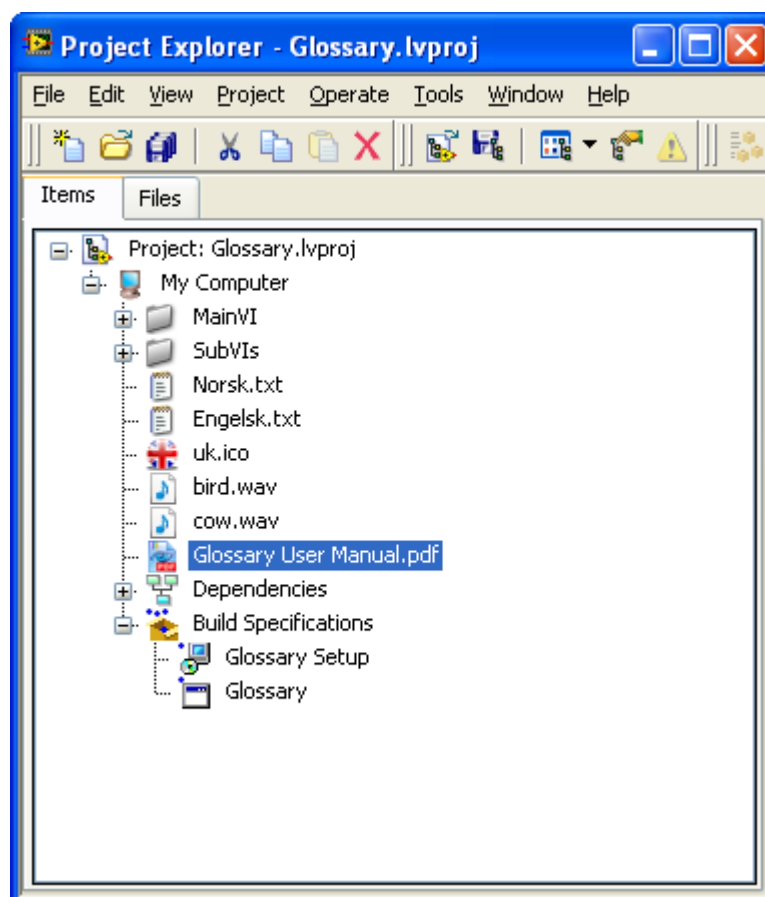

This makes it easy to keep an overview of all your files in your project. You may also use the Project Explorer to create an executable file of your application. In addition you may also create an installation package so you can easily install the application on other computers. As part of the installation the LabVIEW Run-time engine will be installed.

Block Diagram:

The application uses the state machine principle, which makes it easy to create large applications:

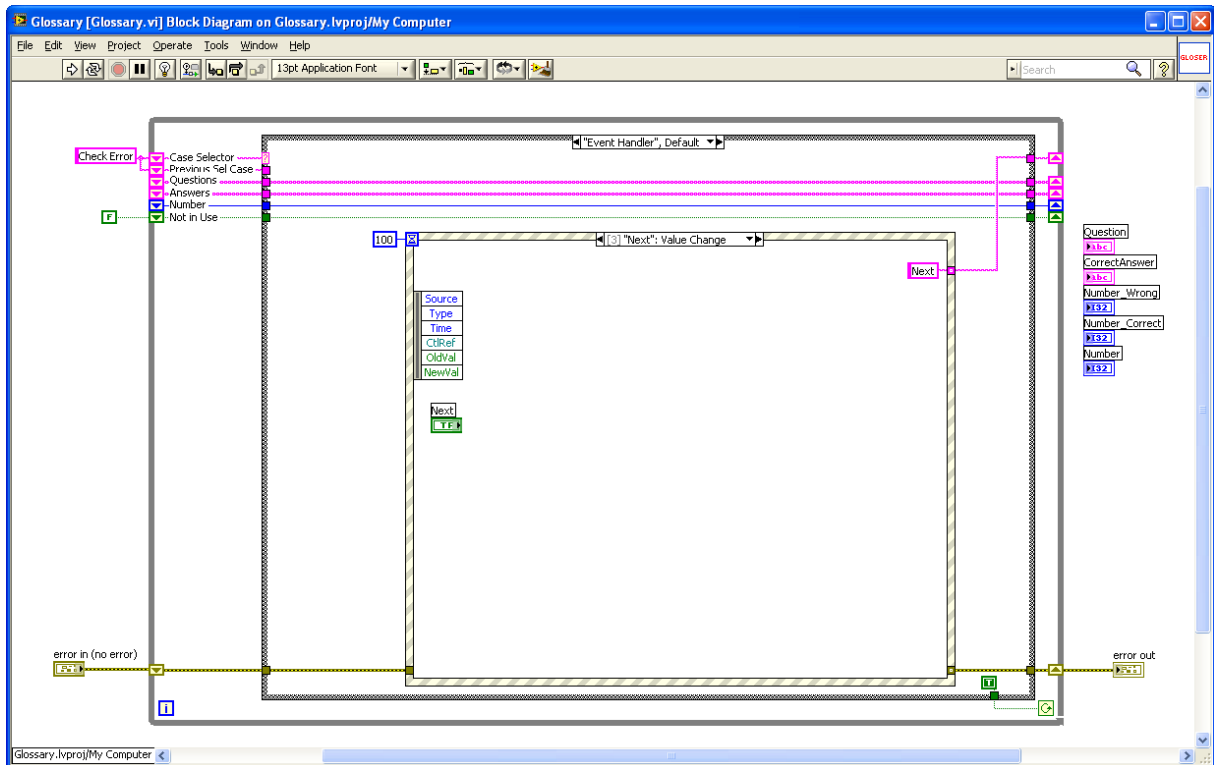

16 Additional Exercises

This chapter lists lots of additional exercises you could try out in order to improve your LabVIEW skills.

Exercise: vCard Reader

Create an application that reads information from a vCard.

vCard is a file format standard for electronic business cards. vCards are often attached to e-mail messages, but can be exchanged in other ways, such as on the World Wide Web. They can contain name and address information, phone numbers, URLs, logos, photographs, and even audio clips.

Example:

```
BEGIN:VCARD
VERSION:2.1
N:Gump;Forrest
FN:Forrest Gump
ORG:Bubba Gump Shrimp Co.
TITLE:Shrimp Man
TEL;WORK;VOICE:(111) 555-1212
TEL;HOME;VOICE:(404) 555-1212
ADR;WORK;;;100 Waters Edge;Baytown;LA;30314;United States of America
LABEL;WORK;ENCODING=QUOTED-PRINTABLE:100 Waters Edge=0D=0ABaytown, LA 30314=0D=0AUSA
ADR;HOME;;;42 Plantation St.;Baytown;LA;30314;United States of America
LABEL;HOME;ENCODING=QUOTED-PRINTABLE:42 Plantation St.=0D=0ABaytown, LA 30314=0D=0AUSA
EMAIL;PREF;INTERNET:forrestgump@example.com
REV:20080424T195243Z
END:VCARD
```

For more information about the vCard format, see <http://en.wikipedia.org/wiki/VCard>.

The application should look something like this:

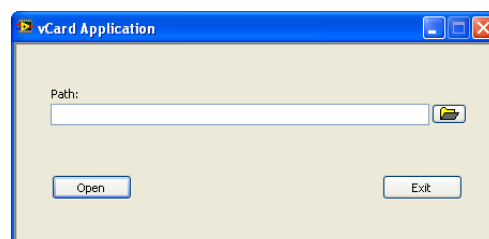

When the user click Open, then a dialog box like this should appear:

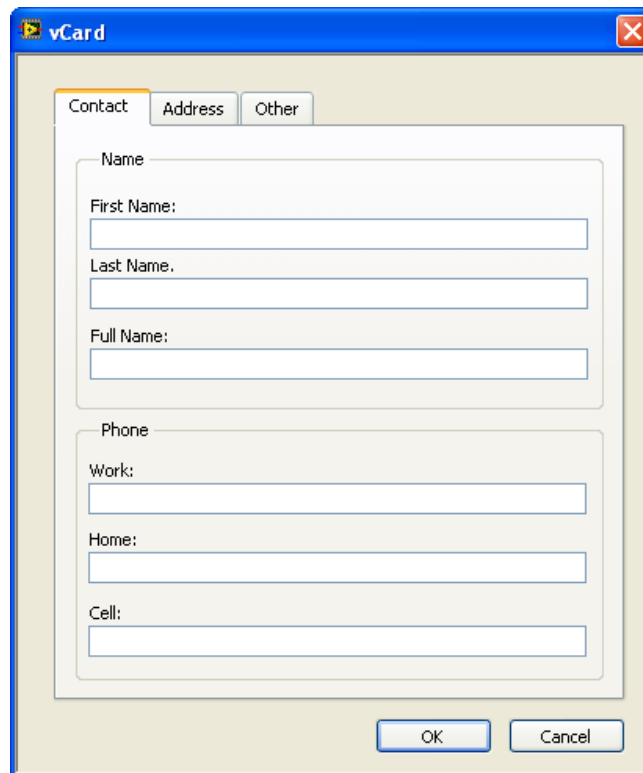

The image shows a Windows-style dialog box titled "vCard". It has three tabs: "Contact", "Address", and "Other". The "Contact" tab is selected. Inside the dialog, there are two main sections: "Name" and "Phone". The "Name" section contains three text input fields labeled "First Name:", "Last Name:", and "Full Name:". The "Phone" section contains three text input fields labeled "Work:", "Home:", and "Cell:". At the bottom right of the dialog, there are two buttons: "OK" and "Cancel".

Requirements:

- Use the Project Explorer
- Use the State Machine principle
- Use the Event Structure
- Use System Controls
- Set the appropriate settings in the VI Properties.
- Create an executable application (vCard.exe)

Exercise: vCard Write & Read

Extend the application in the previous example. You should now be able to both write and read vCard files. The application could look something like this:

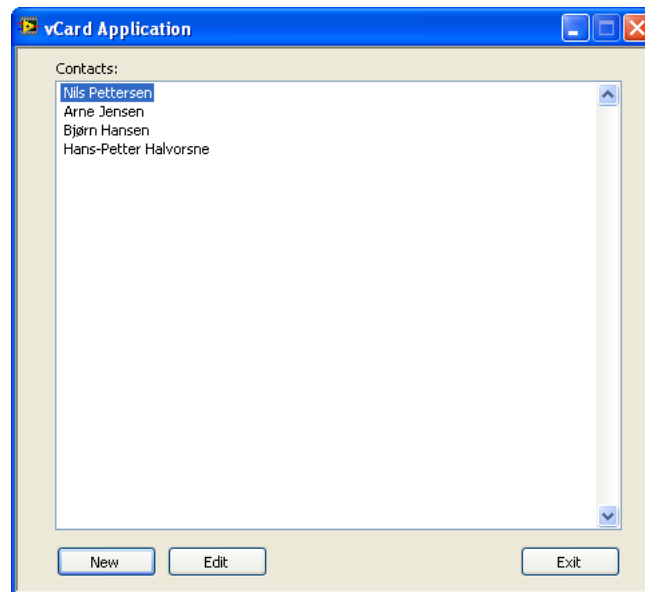

When the user clicks New, the dialog box in the previous exercise appears. The user may enter a new vCard. If the user clicks Edit, a dialog box with the selected contact should appear.

Exercise: Read/Write from .ini files

Read/Write from .ini files. Use the Configuration File VIs:

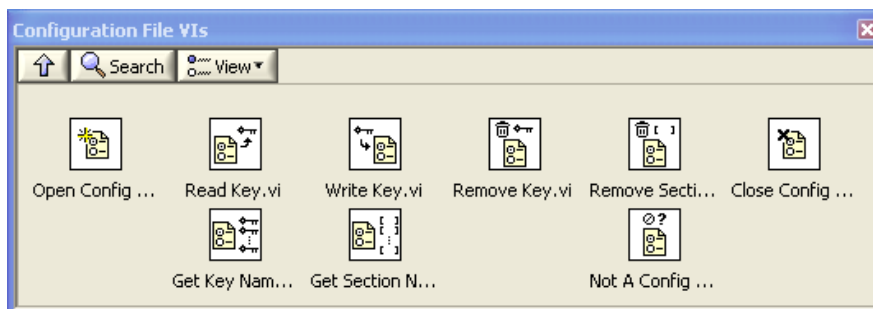

Exercise: ActiveX

Create a simple Web Browser using ActiveX and the Internet Explorer ActiveX control (Microsoft Web Browser)

Use the ActiveX Container from the Containers control palette:

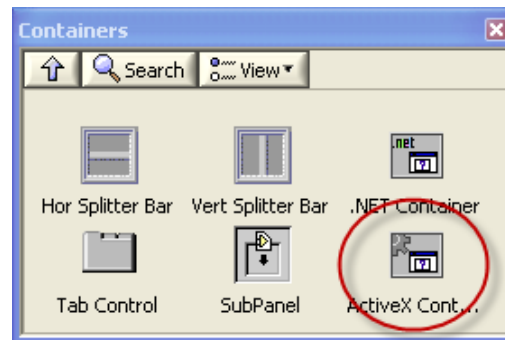

Use the ActiveX function palette:

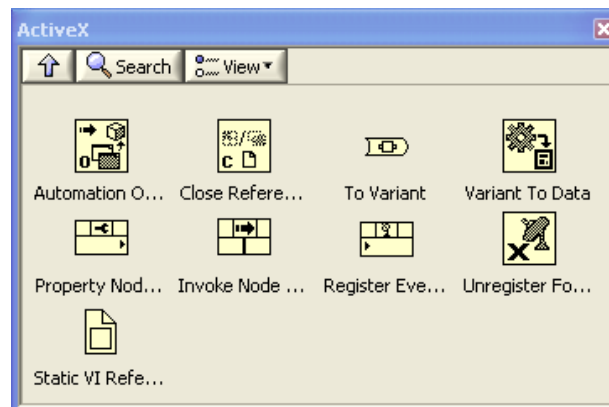

The application could look something like this:

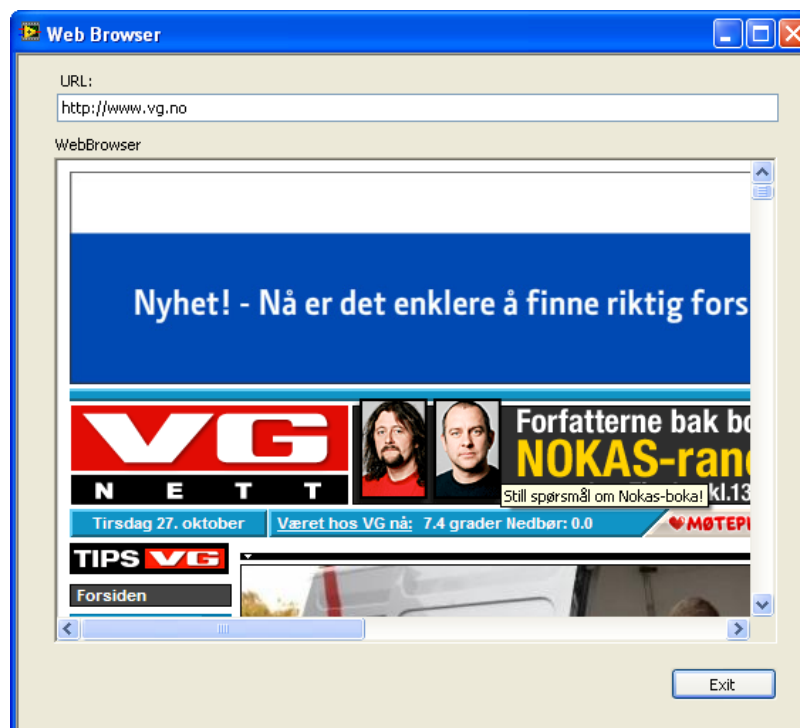

Exercise: Themes

In e.g., ASP.NET we have something called Themes. Themes are used to change the appearance of your whole application regarding to color, font, pictures, etc.

LabVIEW do not offer such a functionality , but try to create your own Theme Configurator, so you can change the appearance of your VI instantly.

Here is an example of how Windows XP handles different Themes:

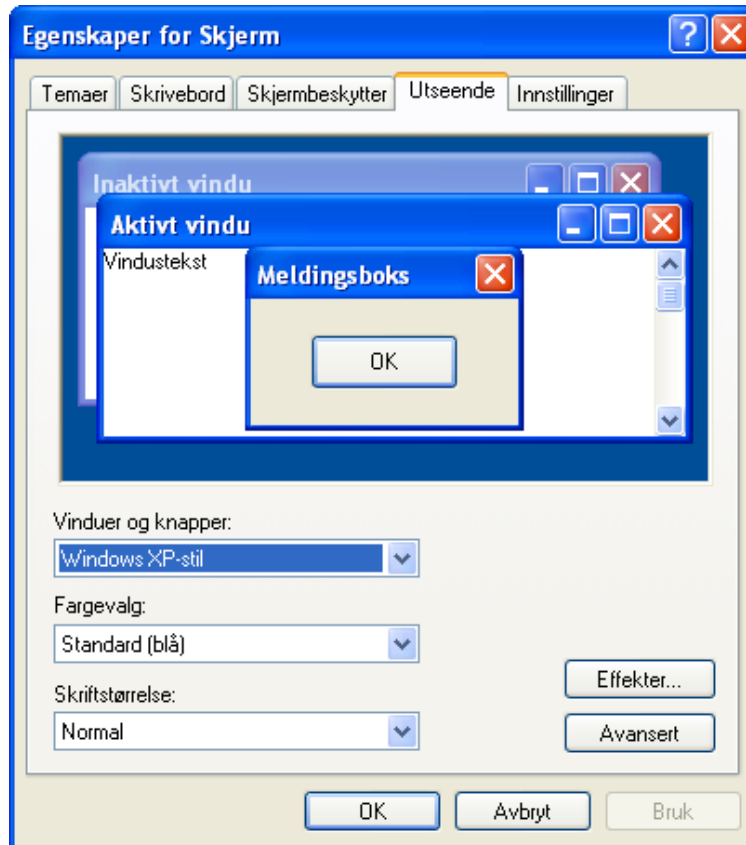

Create a similar Theme Configurator so you may easily change the appearance of your Vis.

17 What's Next?

17.1 My Blog

For more information about LabVIEW, visit my Blog:

<https://www.halvorsen.blog>

LabVIEW resources:

<https://www.halvorsen.blog/documents/programming/labview/>

17.2 Tutorials

This Tutorial is a part of a series with other Tutorials I have made, such as:

- Introduction to LabVIEW
- Data Acquisition in LabVIEW
- Control and Simulation in LabVIEW
- LabVIEW MathScript
- Linear Algebra in LabVIEW
- Datalogging and Supervisory Control in LabVIEW
- Model Predictive Control in LabVIEW
- Wireless Data Acquisition in LabVIEW
- etc.

These Training Kits are available for download (.pdf files, source code, additional resources, etc.) from my blog:

<https://www.halvorsen.blog>

17.3 Additional Resources

You find lots of information about LabVIEW in National Instruments web site:

www.ni.com

17.4 Examples

In the **NI example Finder** (Help → Find Examples...) you find lots of useful examples that you can play with or use as a start when creating your own applications.

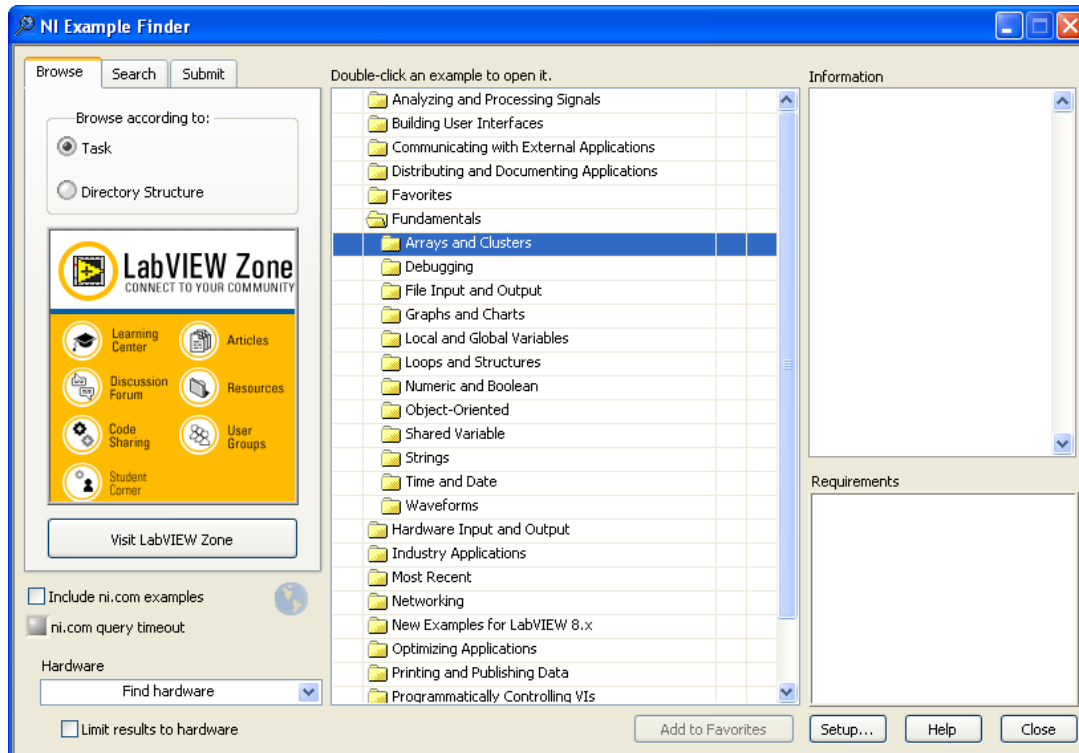

Quick Reference

LabVIEW Keyboard Shortcuts

Objects and Movement	
Shift-click	Selects multiple objects; adds object to current selection.
↑↓→←(arrow keys)	Moves selected objects one pixel at a time.
Shift-↑↓→←	Moves selected objects several pixels at a time.
Shift-click (drag)	Moves selected objects in one axis.
Ctrl-click (drag)	Duplicates selected objects.
Ctrl-Shift-click (drag)	Duplicates selected objects and moves them in one axis.
Shift-resize	Resizes object while maintaining aspect ratio.
Ctrl-resize	Resizes object while maintaining center point.
Ctrl-Shift-resize	Resizes selected object while maintaining center point and aspect ratio.
Ctrl-drag a rectangle in open space	Adds more working space to the front panel or block diagram.
Ctrl-A	Selects all front panel or block diagram items.
Ctrl-Shift-A	Performs last alignment operation on objects.
Ctrl-D	Performs last distribution operation on objects.
Double-click open space	Adds a free label to the front panel or block diagram if automatic tool selection is enabled.
Ctrl-mouse wheel	Scrolls through subdiagrams of a Case, Event, or Stacked Sequence structure.
Spacebar (drag)	Disables preset alignment positions when moving labels or captions.
Ctrl-U	Reroutes all wires and rearranges block diagram objects automatically.

Debugging	
Ctrl-↓	Steps into node.
Ctrl-→	Steps over node.
Ctrl-↑	Steps out of node.

Basic Editing	
Ctrl-Z	Undoes last action.
Ctrl-Shift-Z	Redoes last action.
Ctrl-X	Cuts selected objects.
Ctrl-C	Copies selected objects
Ctrl-V	Pastes last cut or copied objects.

Navigating the LabVIEW Environment	
Ctrl-E	Displays block diagram or front panel windows.
Ctrl-#	Enables or disables grid alignment. (Mac OS) Press the Command-* keys.
Ctrl-/	Maximizes and restores window.
Ctrl-T	Tiles front panel and block diagram windows.
Ctrl-F	Finds objects or text.
Ctrl-G	Searches VIs for next instance of object or text.
Ctrl-Shift-G	Searches VIs for previous instance of object or text.
Ctrl-Shift-F	Displays the Search Results window.
Ctrl-Tab	Cycles through LabVIEW windows.
Ctrl-Shift-Tab	Cycles through LabVIEW windows in reverse order.
Ctrl-Shift-N	Displays the Navigation window.
Ctrl-I	Displays the VI Properties dialog box.
Ctrl-L	Displays the Error list window.
Ctrl-Y	Displays the History window.
Ctrl-Shift-W	Displays the All Windows dialog box.
Ctrl-Space	Displays the Quick Drop dialog box. (Mac OS) Press the Command-Shift-Space keys.

Navigating the VI Hierarchy Window	
Ctrl-D	Redraws the window.
Ctrl-A	Shows all VIs in the window.
Ctrl-click VI	Displays the subVIs and other nodes that make up the VI you select in the window.
Enter †	Finds next node that matches the search string.
Shift-Enter †	Finds previous node that matches the search string.
† After initiating a search by typing in the VI Hierarchy window.	

File Operations	
Ctrl-N	Creates a new, blank VI.
Ctrl-O	Opens an existing VI.
Ctrl-W	Closes the VI.
Ctrl-S	Saves the VI.
Ctrl-Shift-S	Saves all open files.
Ctrl-P	Prints the window.
Ctrl-Q	Quits LabVIEW.

Help	
Ctrl-H	Displays the Context Help window. (Mac OS) Press the Command-Shift-H keys.
Ctrl-Shift-L	Locks the Context Help window.
Ctrl-? or F1	Displays the LabVIEW Help .

Refer to the **LabVIEW Help** for keyboard shortcut variations on other system locales and keyboard layouts.

Tools and Palettes	
Ctrl	Switches to next most useful tool.
Shift	Switches to Positioning tool.
Ctrl-Shift over open space	Switches to Scrolling tool.
Spacebar[†]	Toggles between two most common tools.
Shift-Tab[†]	Enables automatic tool selection.
Tab[†]	Cycles through four most common tools if you disabled automatic tool selection by clicking the Automatic Tool Selection button. Otherwise, enables automatic tool selection.
↑↓→←	Navigates temporary Controls and Functions palettes.
Enter	Navigates into a temporary palette.
Esc	Navigates out of a temporary palette.
Shift-right-click	Displays a temporary version of the Tools palette at the location of the cursor.

[†] If automatic tool selection is disabled.

SubVIs	
Double-click subVI	Displays subVI front panel.
Ctrl-double-click subVI	Displays subVI block diagram and front panel.
Drag VI icon to block diagram	Places that VI as a subVI on the block diagram.
Shift-drag VI icon to block diagram	Places that VI as a subVI on the block diagram with constants wired for controls that have non-default values.
Ctrl-right-click block diagram and select VI from palette	Opens the front panel of that VI.

Execution	
Ctrl-R	Runs the VI.
Ctrl-[†]	Stops the VI.
Ctrl-M	Changes to run or edit mode.
Ctrl-Run button	Recompiles the current VI.
Ctrl-Shift-Run button	Recompiles all VIs in memory.
Ctrl-↓[†]	Moves key focus inside an array or cluster.
Ctrl-↑[†]	Moves key focus outside an array or cluster.
Tab[†]	Navigates the controls or indicators according to tabbing order.
Shift-Tab[†]	Navigates backward through the controls or indicators.

[†] While the VI is running

Text	
Double-click	Selects a single word in a string.
Triple-click	Selects an entire string.
Ctrl-→	Moves forward in string by one word.
Ctrl-←	Moves backward in string by one word.
Home	Moves to beginning of current line in string.
End	Moves to end of current line in string.
Ctrl-Home	Moves to beginning of entire string.
Ctrl-End	Moves to end of entire string.
Shift-Enter	Adds new items when entering items in enumerated type controls and constants, ring controls and constants, or Case structures.
Esc	Cancels current edit in a string.
Ctrl-Enter	Ends text entry.
Ctrl=	Increases the current font size.
Ctrl-	Decreases the current font size.
Ctrl-0	Displays the Font dialog box.
Ctrl-1[†]	Changes to the Application font.
Ctrl-2[†]	Changes to the System font.
Ctrl-3[†]	Changes to the Dialog font.
Ctrl-4[†]	Changes to the current font.

[†] In the **Font** dialog box.

Wiring	
Ctrl-B	Removes all broken wires.
Esc, right-click, or click terminal	While wiring, cancels a wire you started.
Single-click wire	Selects one segment.
Double-click wire	Selects a branch.
Triple-click wire	Selects entire wire.
A	While wiring, disables automatic wire routing temporarily.
Double-click	While wiring, tacks down wire without connecting it.
spacebar	While wiring, switches the direction of a wire between horizontal and vertical.
spacebar	While moving objects, toggles automatic wiring.
Ctrl-click input on function with two inputs	Switches the two input wires.
Shift-click	While wiring, undoes last point where you set a wire.

Note: The **Ctrl** key in these shortcuts corresponds to the **Option** or **Command** key on Mac OS and the **Alt** key on Linux.



Introduction to LabVIEW

Hans-Petter Halvorsen

Copyright © 2017

E-Mail: hans.p.halvorsen@usn.no

Web: <https://www.halvorsen.blog>



<https://www.halvorsen.blog>